

PALMER FIXTURE

# FULL LINE

PRODUCT CATALOG



# A Centennial of Quality *and Beyond.*



Quality Since 1907.

## Table of Contents

4	History of Palmer	6	Product Catalog Key
6	LEED Information	7	ADA Compliancy
8	Touchless Hand Dryers	17	Custom BluStorm
18	Touchless Roll Towel Dispensers	20	Pad Printing
21	Roll Towel Dispensers	22	Folded Towel Dispensers
23	Markets Served	24	Jumbo Tissue Dispensers
26	Standard Tissue Dispensers	28	Bulk Soap Dispensers
31	Bulk Liquid Soap Dispensers	32	Sani Suds®
34	Signs, Safety & Maintenance	36	Napkin Dispensers
38	Keys	39	Company Information

# THE HISTORY

## — OF PALMER FIXTURE —

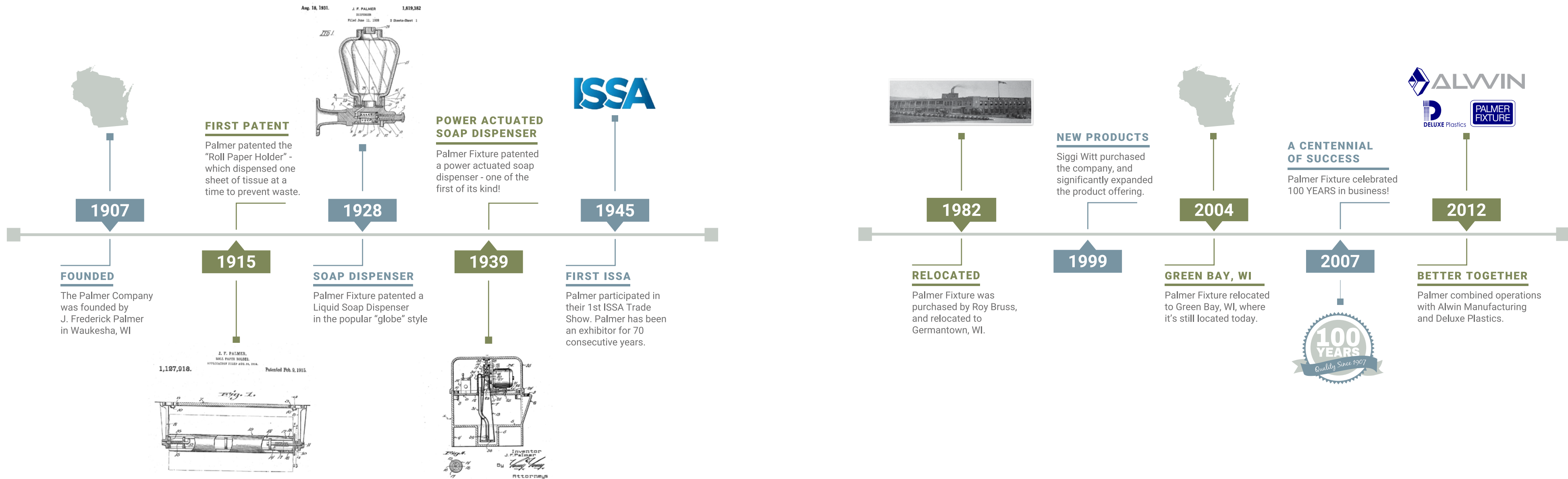















# Product Catalog Key

Watch for these icons throughout the catalog to indicate product details:

-  Eco-Friendly Product
-  ADA Compliant Product
-  Pad Printing Available
-  Product Made in the U.S.A.

## Product Color Key:

- |  |   |   |
|--|---|---|
|  (01) Dark Translucent  |  (11) Brushed Chrome |  (17) White  |
|  (02) Black Translucent |  (12) Bright Chrome  |  (18) Green  |
|  (03) White Translucent |  (13) Brushed Steel  |  (19) Yellow |
|  (08) Platinum          |  (15) Blue           |  (21) Grey   |
|  (09) Brushed Stainless |  (16) Black          |  (22) Red    |

# LEED Credit Information

## What is LEED?

LEED, or Leadership in Energy & Environmental Design, is a green building certification program that recognizes best-in-class building strategies and practices. To receive LEED certification, building projects satisfy prerequisites and earn points to achieve different levels of certification. Prerequisites and credits differ for each rating system, and teams choose the best fit for their project.



### Which Palmer Fixture Products earn credits?

The **BluStorm® High Speed Hand Dryer** (pg. 12) earns LEED Credits for **EAc1: Optimize Energy Performance** and **EAp2: Minimum Energy Performance**

The **EcoStorm® High Speed Hand Dryer** (pg. 14) earns LEED Credits for **EAc1: Optimize Energy Performance** and **EAp2: Minimum Energy Performance**

For more information on the LEED Program and detailed requirements, visit [www.usgbc.org/leed](http://www.usgbc.org/leed)

# ADA Compliant Products

The Americans with Disabilities Act (ADA) defines the accessible requirements for the design and construction of washroom space in the United States. Detailed below are examples of the ADA installation requirements for hand dryers.

## As for the visually impaired, Rule 4.4.1 states:

Objects projecting from walls (for example, telephones) with their leading edges between 27 and 80 inches (685 mm and 2020 mm) above the finished floor shall protrude no more than 4 inches (100 mm) into walks, halls, corridors, passageways, or aisles. Objects mounted with their leading edges at or below 27 inches (685 mm) above the finished floor may protrude any amount.

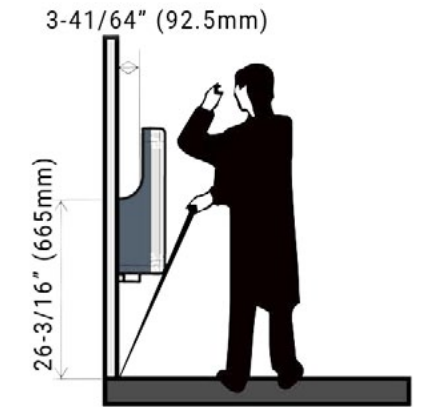

## According to ADA Regulation 4.2.5, concerning forward reach:

If the clear floor space only allows forward approach to an object, the maximum high forward reach allowed shall be 48 inches (1220 mm). The minimum for low forward reach is 15 inches (380 mm).

ADA Accessibility Guidelines (as measured from finished floor)	
Forward Reach Ranges - Unobstructed	
48" H max.	15" H min.

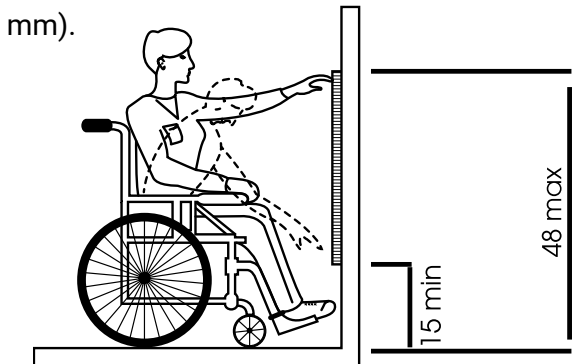

The above information is for informational purposes only and not intended to be an alternative to the ADA Accessibility Guidelines or specifications. For complete information on current ADA requirements, visit [www.ada.gov](http://www.ada.gov)



The **iStorm2** high speed hand dryer. This intuitive high speed hand dryer dries hands in 10 seconds. Users dry their hands in a natural comfortable position without water splash-back. The **iStorm2** utilizes water absorbing ceramic technology eliminating water overflow preventing hazardous wet floors. The **iStorm2** has an airspeed adjustment, on-off heater switch, and dual-color LED sensor indicators for a superior hand-dry.



**Technical Specifications**

<b>Model #</b>	<b>Color</b>
HD0983-08, HD0984-08, HD0985-08	Platinum
HD0983-16, HD0984-16, HD0985-16	Black
HD0983-17, HD0984-17, HD0985-17	White
<b>Width:</b> 12-43/64" <b>Height:</b> 24-19/32" <b>Depth:</b> 7-9/32"	
<b>Weight:</b> 23.8 lbs <b>Sound Level:</b> 65dB - 78dB MAX	
<b>Material:</b> Polycarbonate ABS (ION+)	
<b>Motor Type:</b> 1HP, 350-700 Watts	
<b>Thermal Protection:</b>	
	Motor Shuts Off at 275°F (135°C)
	Heater Shuts Off at 288°F (142°C)
<b>Operating Airflow:</b> 19,476 LFM, Adjustable	
<b>Air Output Temperature:</b>	
	140°F (60°C)
	Ambient Temperature 68°F (20°C)
<b>Isolation:</b> Class 1 <b>Drip Proof:</b> IP23	
<b>Watts:</b> 1600W (700W w/ heater off)	
<b>RPM:</b> 11,000 - 20,000, Adjustable	
<b>Voltage &amp; Amps:</b>	
HD0983	110/120 Volts 12.2-13.3 Amps
HD0984	208/220 Volts 5.7-6.6 Amps
HD0985	277 Volts 6.6 Amps

**Mounting Heights**

from bottom of dryer to the finished floor

<b>Men</b>	26-1/6"
<b>Women</b>	23-5/64"
<b>Children (4-10)</b>	9-59/64"
<b>Children (11-16)</b>	15-5/64"
<b>Disabled</b>	13-5/8"

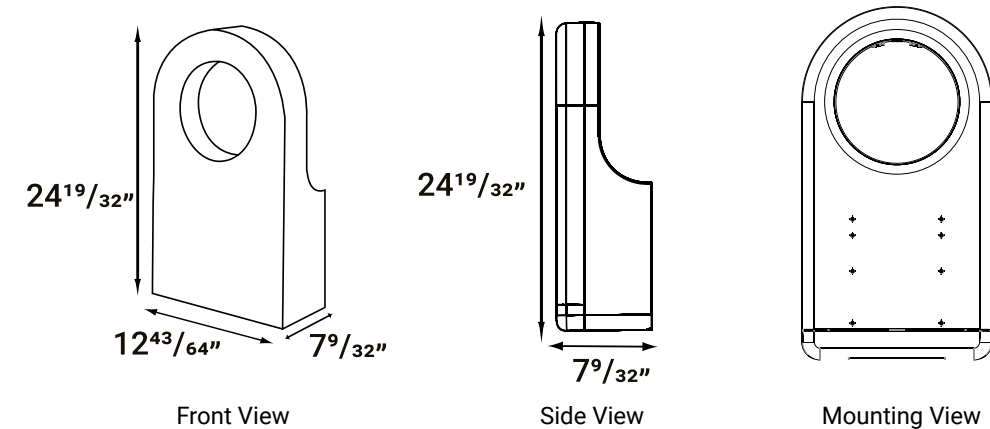

10 - 15 SECOND DRY TIME  
**ADA COMPLIANT**  
 HYGIENIC ERGONOMIC  
**HEPA FILTER** ION+ COATING  
 LED SENSOR  
 POWERFUL PERFORMANCE





The **BluStorm Bolt** offers patented dual air outlets and quiet operation. The wide drying area with blue action light makes for an efficient 10-15 second hand drying experience. The **BluStorm Bolt** has a small footprint, protruding less than 4" from the wall. With a smooth appearance and hidden cover screws, the **BluStorm Bolt** is an attractive and efficient hand drying option.

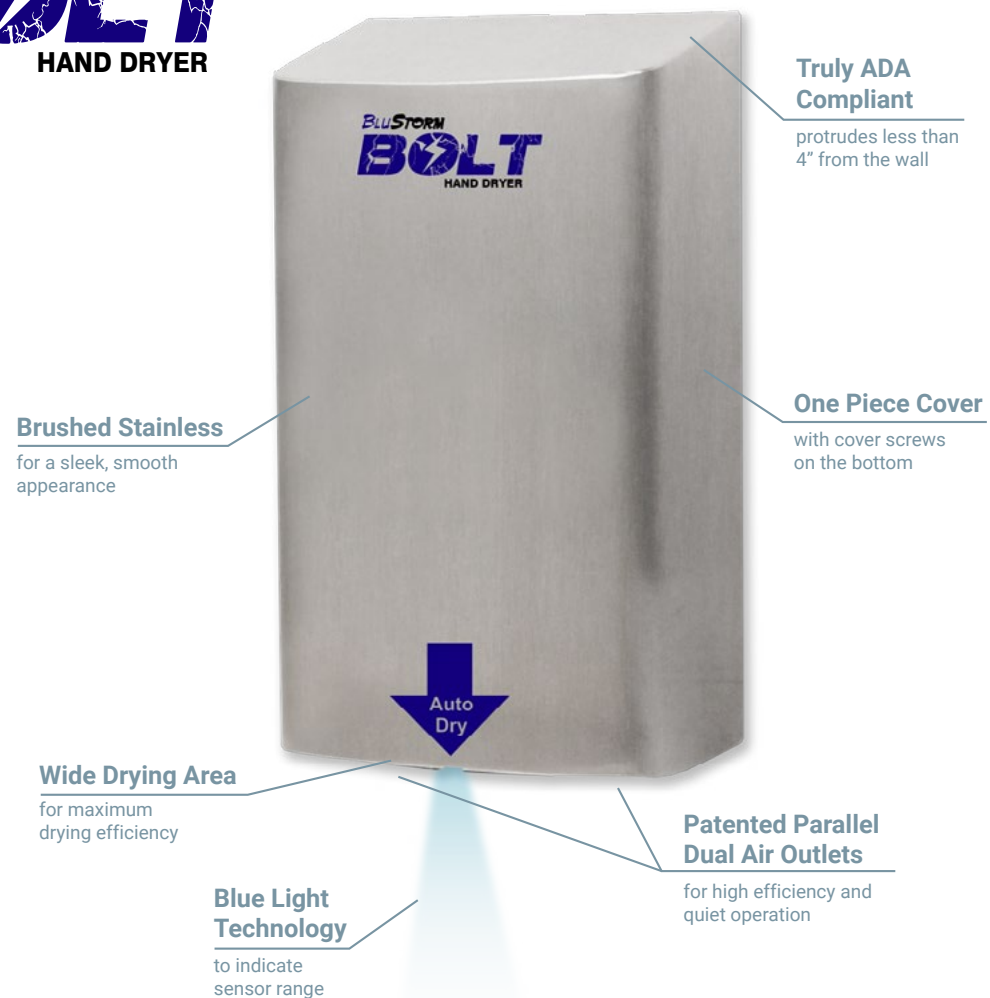

### Technical Specifications

<b>Model #</b>	<b>Color</b>	
HD0923-09	Brushed Stainless	
HD0924-09	Brushed Stainless	
<b>Width: 5-63/64"</b>	<b>Height: 10-9/16"</b>	<b>Depth: 3-15/16"</b>
<b>Weight: 8.4 lbs</b>	<b>Sound Level: 76.2dB</b>	
<b>Material: Stainless Steel</b>		
<b>Motor Type: 11/16HP, Brush Type, Dual Ball Bearings</b>		
<b>Thermal Protection:</b>		
Motor Shuts Off at 275°F (135°C)		
Heater Shuts Off at 185°F (85°C)		
<b>Operating Airflow: 21,243 LFM</b>		
<b>Air Output Temperature:</b>		
131°F (55°C), Adjustable		
Ambient Temperature 77°F (25°C)		
<b>Isolation: Class 1 Drip Proof: IP23</b>		
<b>Watts: 900W (450W w/ heater off)</b>		
<b>RPM: 16,000 - 29,000, Adjustable</b>		
<b>Voltage &amp; Amps:</b>		
HD0923	110/120 Volts 4.17-8.33 Amps	
HD0924	220/240 Volts 1.91-3.82 Amps	

### Mounting Heights

from bottom of dryer to the finished floor

<b>Men</b>	50"
<b>Women</b>	47"
<b>Children (4-7)</b>	35"
<b>Children (8-10)</b>	39"
<b>Children (11-13)</b>	43"
<b>Children (14-16)</b>	47"
<b>Disabled</b>	40"

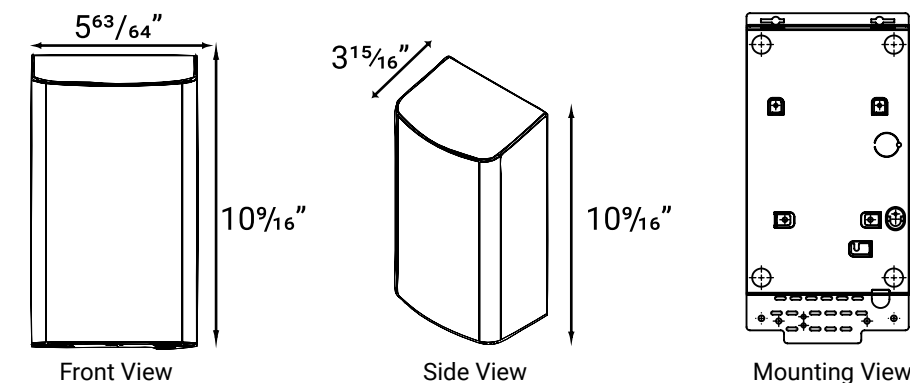

**POWERFUL PERFORMANCE**  
**10 - 15 SECOND DRY TIME**  
**ADA COMPLIANT**  
**BLUE LIGHT TECHNOLOGY**  
**ULTRA THIN 4" PROFILE**  
**4 AMP OPERATION** WITH HEATER TURNED OFF





With advancements in technology and improvements to hand dryers, more people are switching from paper towel due to the environmental benefits, cost savings, and hygiene. Multiple studies have shown that airborne bacteria is not spread when using hand dryers. Our stainless steel **BluStorm High Speed Hand Dryer** provides a 95% cost savings versus paper towels.



### Technical Specifications

Model #	Color	
HD0950-09, HD0951-09	Brushed Stainless	
<b>Width:</b> 8-15/16"	<b>Height:</b> 10-15/32"	<b>Depth:</b> 6-31/32"
<b>Weight:</b> 12.8 lbs	<b>Sound Level:</b> 77±3dB	
HD0955-09	Brushed Stainless	
<b>Width:</b> 9-35/64"	<b>Height:</b> 20-3/16"	<b>Depth:</b> 7-1/8"
<b>Weight:</b> 20.7 lbs	<b>Sound Level:</b> 77±3dB	
<b>Material:</b> Stainless Steel		
<b>Motor Type:</b> 15/16HP, 700W Brush Type, Dual Ball Bearings		
<b>Thermal Protection:</b>		
Motor Shuts Off at 275°F (135°C)		
Heater Shuts Off at 221°F (105°C)		
<b>Operating Airflow:</b> 19,860 LFM, Adjustable		
<b>Air Output Temperature:</b>		
113°F (45°C)		
Ambient Temperature 68°F (20°C)		
<b>Isolation:</b> Class 1 <b>Drip Proof:</b> IPX1		
<b>Watts:</b> 1600W		
<b>RPM:</b> 12,000 - 18,000, Adjustable		
<b>Voltage &amp; Amps:</b>		
HD0950, 955	110/120 Volts	12.5-13.4 Amps
HD0951	220/240 Volts	8-8.5 Amps

### Mounting Heights

from bottom of dryer to the finished floor

<b>Men</b>	43"
<b>Women</b>	41"
<b>Children (3-10)</b>	33"
<b>Children (11-18)</b>	39"
<b>Disabled</b>	35"

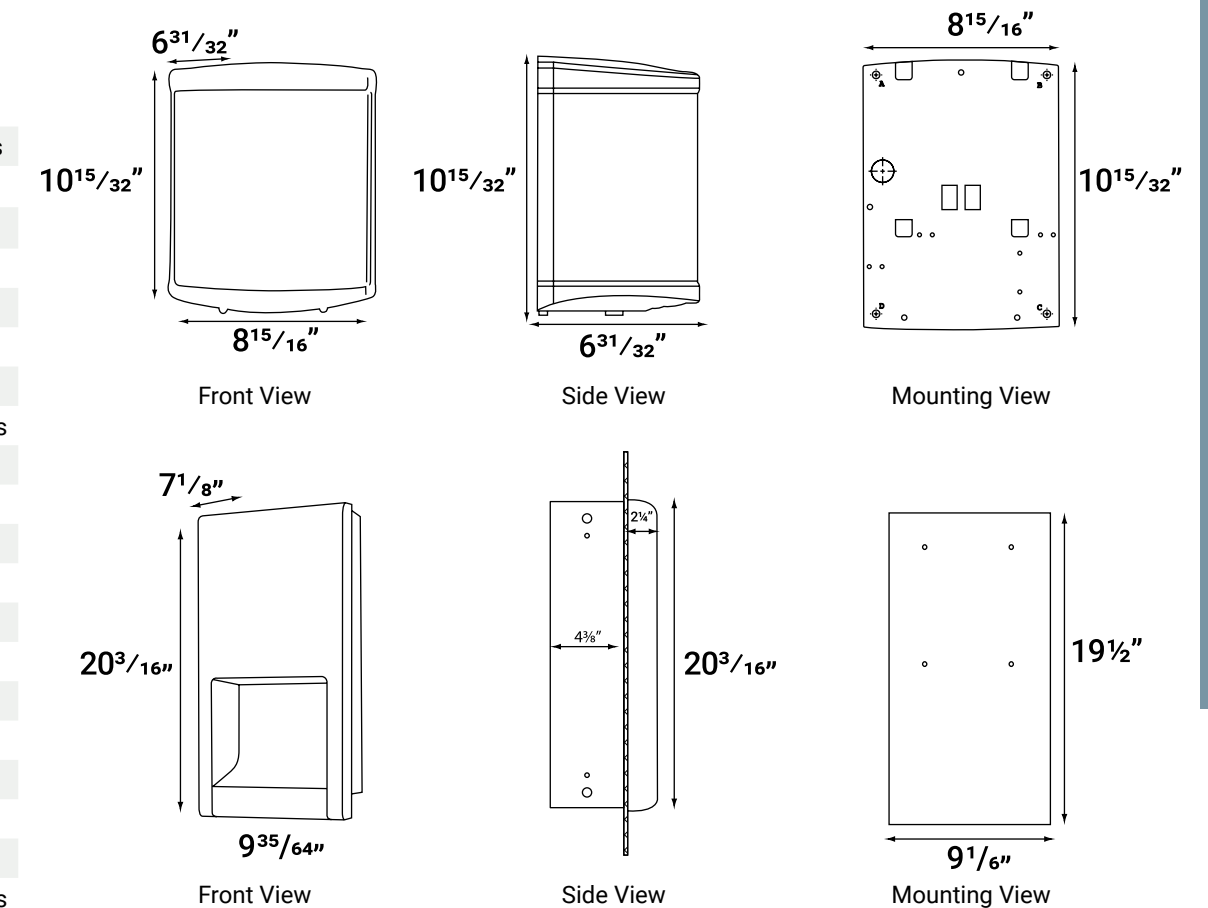

**95% COST SAVINGS** VERSUS USING PAPER TOWELS  
**10 - 15 SECOND DRY TIME**  
**ADA COMPLIANT**  
 FAST DRYING WITH LESS NOISE  
**BLUE LIGHT TECHNOLOGY**

Due to the environmental benefits, cost savings, and hygiene, many users are making the switch from paper towels to hand dryers. The **EcoStorm®** operates at only 1000 Watts, using 90% less energy than conventional dryers, and offers a 97% cost savings versus paper towels! The new and improved **EcoStorm Hush** is one of the quietest hand dryers in the industry!

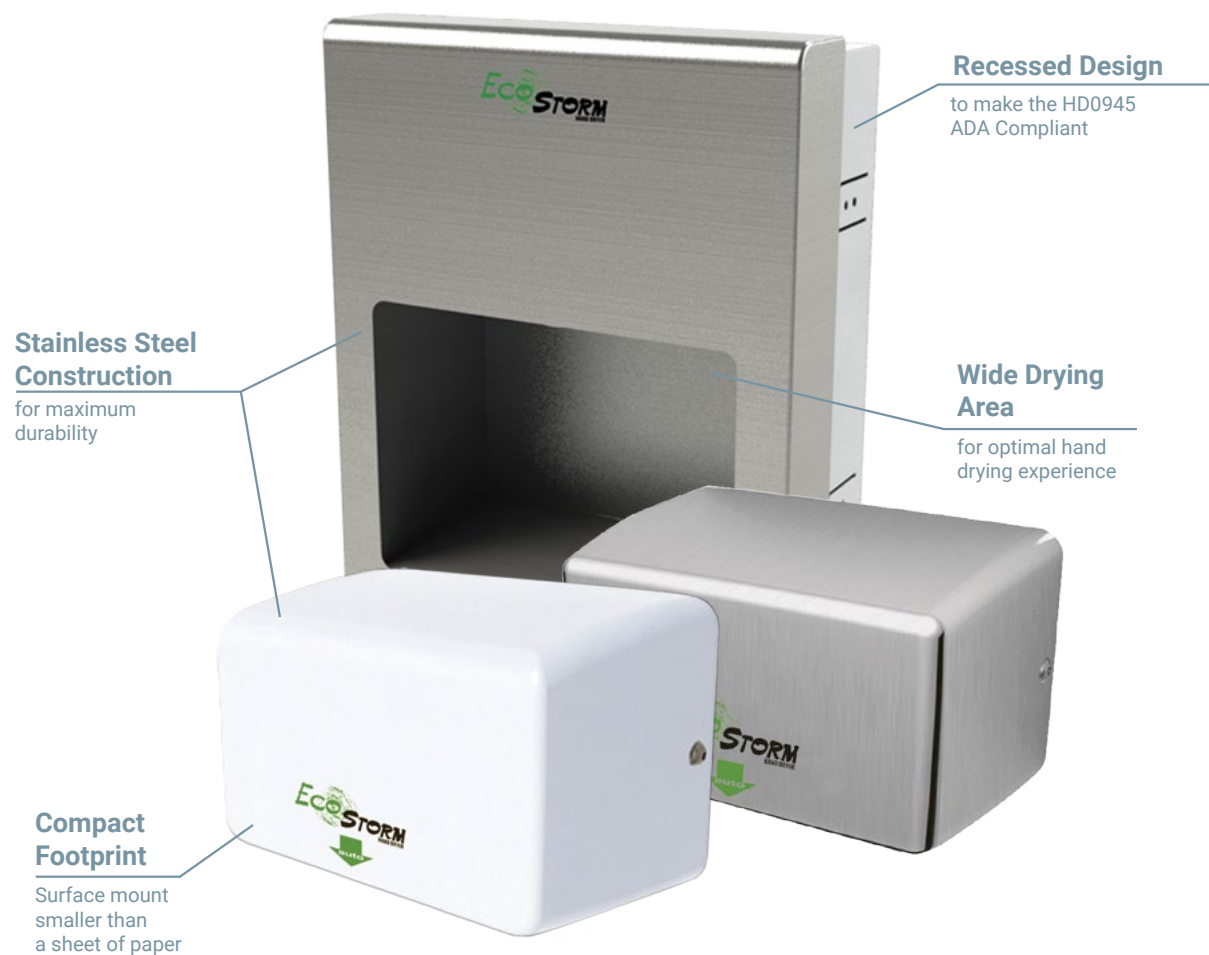

### Technical Specifications

Model #	Color	
HD0940-09, HD0941-09	Brushed Stainless	
HD0940-09, HD0941-17	White	
<b>Width:</b> 9-27/32"	<b>Height:</b> 7-3/32"	<b>Depth:</b> 5-29/64"
<b>Weight:</b> 8.4 lbs	<b>Sound Level:</b> 63.5dB	
Model #	Color	
HD0945-09	Brushed Stainless	
<b>Width:</b> 10-45/64"	<b>Height:</b> 15-17/32"	<b>Depth:</b> 5-1/2"
<b>Weight:</b> 15.4 lbs	<b>Sound Level:</b> 63.5dB	
<b>Material:</b> Stainless Steel		
<b>Motor Type:</b> 3/4HP, 500W Brush Type, Dual Ball Bearings		
<b>Thermal Protection:</b>		
	Motor Shuts Off at 221°F (105°C)	
	Heater Shuts Off at 282°F (139°C)	
<b>Operating Airflow:</b> 17,752 LFM, Adjustable		
<b>Air Output Temperature:</b>		
	131°F (55°C)	
	Ambient Temperature 77°F (25°C)	
<b>Isolation:</b> Class 1 <b>Drip Proof:</b> IPX1		
<b>Watts:</b> 1000W		
<b>RPM:</b> 29,000, Adjustable		
<b>Voltage &amp; Amps:</b>		
HD0940, 945	110/120 Volts	8.4-10.5 Amps
HD0941	220/240 Volts	4.2-5.5 Amps

### Mounting Heights

from bottom of dryer to the finished floor

<b>Men</b>	40"
<b>Women</b>	38"
<b>Children (4-7)</b>	32"
<b>Children (8-10)</b>	34"
<b>Children (11-13)</b>	36"
<b>Children (14-16)</b>	38"
<b>Disabled</b>	34"



Palmer Fixture • Phone: 800.558.8678 • Email: info@palmerfixture.com • www.palmerfixture.com

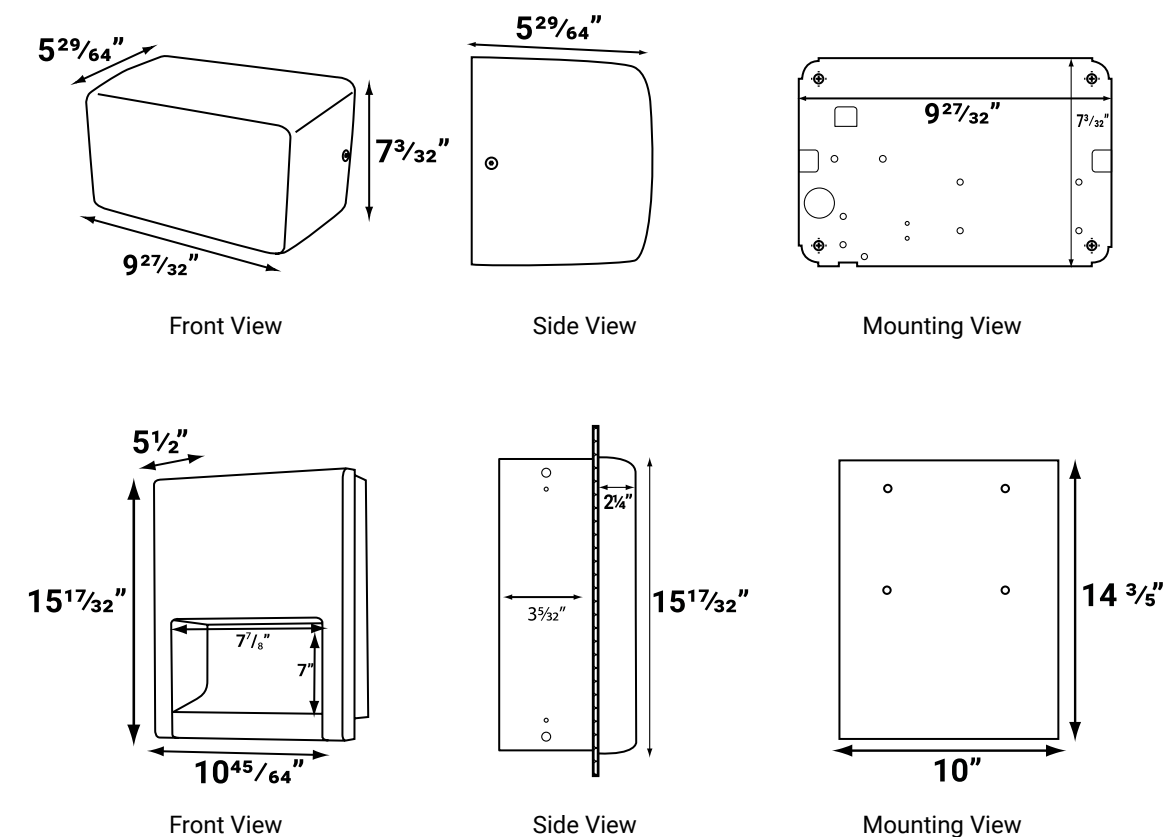

**10 - 15 SECOND DRY TIME**  
**97% COST SAVINGS** VERSUS USING PAPER TOWELS  
**ADA COMPLIANT**  
 ULTRA QUIET AT 63.5dB  
 UNITS ARE MANUFACTURED WITH RECYCLED MATERIALS





**Conventional Series Hand Dryer**

Model: HD0901

Model #	Color
HD0901-11	Brushed Chrome
HD0901-17	White
<b>Width:</b> 11-3/16"	<b>Height:</b> 9-3/4" <b>Depth:</b> 8"
<b>Weight:</b> 15.4 lbs	<b>Sound Level:</b> 70±3dB
<b>Material:</b> Steel	
<b>Motor Type:</b> 1/4HP, 200W Brush	
<b>Operating Airflow:</b> 5,514 LFM	
<b>Watts:</b> 1800-2200W <b>RPM:</b> 5,500	



**Painted Cast Aluminum Hand Dryer**

Model: HD0907

Model #	Color
HD0907-17	White
<b>Width:</b> 9-3/4"	<b>Height:</b> 8-3/4" <b>Depth:</b> 6-3/4"
<b>Weight:</b> 11.2 lbs	<b>Sound Level:</b> 55±3dB
<b>Material:</b> Aluminum	
<b>Motor Type:</b> Brushless, 100W	
<b>Operating Airflow:</b> 3,242 LFM	
<b>Watts:</b> 1800W <b>RPM:</b> 2,850	



**High Grade Fire-Retardant ABS Hand Dryer**

Model: HD0903

Model #	Color
HD0903-17	White
<b>Width:</b> 10-1/2"	<b>Height:</b> 8-3/4" <b>Depth:</b> 6-3/4"
<b>Weight:</b> 8.4 lbs	<b>Sound Level:</b> 55±3dB
<b>Material:</b> ABS Plastic	
<b>Motor Type:</b> 1/8 HP, Brushless, 100W	
<b>Operating Airflow:</b> 3,242 LFM	
<b>Watts:</b> 1800W <b>RPM:</b> 2,850	



# Make It Your Own!

Palmer Fixture offers the option of Custom Designed BluStorm Covers - a decal that completely surrounds the outside of the BluStorm High Speed Hand Dryer! We will gladly help you achieve the desired aesthetic, which can showcase your trademark, logo, or design.



There is a minimum order requirement of 12 BluStorm High Speed Hand Dryers to be eligible for custom designed units. Additional fees apply in addition to the cost of the hand dryer(s).

**Want to design your own?**

We'll help you get started! Contact us by calling **800.558.8678** for more details.



**Electra Electronic Touchless Roll Towel Dispenser** Model: TD0245

Model #	Color
TD0245-01	Dark Translucent
TD0245-02	Black Translucent
TD0245-03	White Translucent
TD0246-01	Dark Translucent
TD0246-02	Black Translucent

**Width:** 11-1/4" **Height:** 15" **Depth:** 9-1/2"  
**Weight:** 7 lbs **Key Type:** 1  
**Capacity:** Roll Towel 8" W & 8" D, 2-3/4" Stub (1-1/2" Core)



**INSPIRE Electronic Touchless Roll Towel Dispenser** Model: TD0235

Model #	Color
TD0235-01	Dark Translucent
TD0235-02	Black Translucent
TD0235-03	White Translucent

**Width:** 11-1/2" **Height:** 13-3/8" **Depth:** 8-1/2"  
**Weight:** 4 lbs **Key Type:** 1  
**Capacity:** Roll Towel 8" W & 8" D (1-1/2" Core)



**Mechanical Auto-Cut Roll Towel Dispenser** Model: TD0208

Model #	Color
TD0208-01A	Dark Translucent
TD0208-02A	Black Translucent
TD0208-03A	White Translucent

**Width:** 12-1/2" **Height:** 14-3/4" **Depth:** 9-1/4"  
**Weight:** 7 lbs **Key Type:** 1  
**Capacity:** Roll Towel 8" W & 8" D (1-1/2" Core)



**Mechanical Auto-Cut Roll Towel Dispenser** Model: TD0201

Model #	Color
TD0201-01	Dark Translucent
TD0201-02	Black Translucent
TD0201-03	White Translucent

**Width:** 11-1/2" **Height:** 15-1/4" **Depth:** 9"  
**Weight:** 4 lbs **Key Type:** 1  
**Capacity:** Roll Towel 8" W & 8" D (1-1/2" Core)



**Electronic Hands-Free Roll Towel Dispenser** Model: TD0234

Model #	Color
TD0234-01	Dark Translucent
TD0234-02	Black Translucent
TD0234-03	White Translucent

**Width:** 11-1/2" **Height:** 11-1/2" **Depth:** 7-3/4"  
**Weight:** 4 lbs **Key Type:** 1  
**Capacity:** Roll Towel 8" W & 6" D (1-1/2" Core)



**Mechanical Auto-Cut Roll Towel Dispenser** Model: TD0400

Model #	Color
TD0400-01	Dark Translucent

**Width:** 11-3/4" **Height:** 16-1/4" **Depth:** 8-3/4"  
**Weight:** 7 lbs **Key Type:** 1  
**Capacity:** Roll Towel 8" W & 8" D, 2-3/4" Stub (1-1/2" Core)



**Mechanical Hands-Free Roll Towel Dispenser** Model: TD0202

Model #	Color
TD0202-01	Dark Translucent
TD0202-02	Black Translucent
TD0202-03	White Translucent

**Width:** 11-1/4" **Height:** 13-1/4" **Depth:** 7-1/4"  
**Weight:** 4 lbs **Key Type:** 1  
**Capacity:** Roll Towel 8" W & 6" D (1-1/2" Core)



**Mechanical Auto-Cut Roll Towel Dispenser** Model: TD0207

Model #	Color
TD0207-01	Dark Translucent
TD0207-01B	Dark Translucent

**Width:** 10-1/2" **Height:** 15-3/4" **Depth:** 8-3/4"  
**Weight:** 9 lbs **Key Type:** 1  
**Capacity:** Roll Towel 8" W & 8" D (1-1/2"-2" Core)

## Pad Printing

Palmer Fixture offers several customizable dispensers. Your logo will surely stand out when printed in our metallic silver ink. Logos are printed on the bottom center of the dispenser cover. The logo can be up to 2.5 inches wide, with a height of up to 1.5 inches. Our Made in the U.S.A. dispensers provide a consistent, first-class quality offering to you and your customers.

Add your logo today for a one of a kind look!

Look for the  throughout this catalog to indicate which dispensers are available for customization.



### How to Get YOUR Logo on Palmer Dispensers

Contact us via email at [info@palmerfixture.com](mailto:info@palmerfixture.com) or by calling 1-800-558-8678 for a quote.

### Dispensers Available for Customization

Toilet Tissue Dispensers	Model #
Single 9" Tissue 3-3/8" Core	RD0026-01/02
Twin 9" Tissue 3-3/8" Core	RD0027-01/02
13" Tissue Roll Dispenser	RD0330-01/02
Two-Roll Standard Tissue Dispenser	RD0025-01
Two-Roll Standard Tissue Dispenser	RD0028-01
Mini-Twin Standard Tissue Dispenser	RD0321-01/02
Soap & Foam Dispensers	Model #
Manual Bulk Soap Dispenser 30oz	SD0030-01
Manual Bulk Soap Dispenser 46oz	SD0046-01
Manual Bulk Foam Soap Dispenser 30oz	SF2144-01
Manual Bulk Foam Soap Dispenser 46oz	SF2135-01
Automatic Sani Suds Dispenser	SF0305-01/02
Manual Sani Suds Dispenser	SF0407-01/-02

Towel Dispensers	Model #
Multi/C-Fold Towel Dispenser	RD0175-01
Multifold Towel Dispenser	TD0179-01/02
Roll Towel Economy Lever	TD0210-01
Pushbar Towel Dispenser	TD0215-01/02
Impress Lever Roll Towel Dispenser	TD0220-01/02
Centerpull Self Adjusting Dispenser	TD0255-01/02
InSpire Electronic Hands-Free Dispenser	TD0235-01/02
Electra Automatic Roll Towel Dispenser	TD0245-01/02
Hands-Free Auto-Cut Roll Towel Dispenser	TD0201-01/02

Toilet Seat Cover Dispensers	Model #
Toilet Seat Cover Dispenser	TS0142-01

List subject to change.



### Impress Lever Roll Towel Dispenser Model: TD0220

Model #	Color
TD0220-01	Dark Translucent
TD0220-02	Black Translucent
TD0220-03	White Translucent
<b>Width:</b> 11-3/4"	<b>Height:</b> 13-3/4" <b>Depth:</b> 9"
<b>Weight:</b> 4 lbs	<b>Key Type:</b> 1
<b>Capacity:</b> Roll Towel 8" W & 8" D (1-1/2" Core)	



### Auto-Transfer Push Bar Roll Towel Dispenser Model: TD0215

Model #	Color
TD0215-01	Dark Translucent
TD0215-02	Black Translucent
TD0215-03	White Translucent
<b>Width:</b> 10-1/2"	<b>Height:</b> 15-1/2" <b>Depth:</b> 7-3/4"
<b>Weight:</b> 9 lbs	<b>Key Type:</b> 1
<b>Capacity:</b> Roll Towel 8" W & 8" D, 2-3/4" Stub (1-1/2"-2" Core)	



### Push Lever Roll Towel Dispenser Model: TD0210

Model #	Color
TD0210-01	Dark Translucent
<b>Width:</b> 10-1/2"	<b>Height:</b> 15-1/2" <b>Depth:</b> 8-3/4"
<b>Weight:</b> 7 lbs	<b>Key Type:</b> 1
<b>Capacity:</b> Roll Towel 8" W & 8" D (1-1/2"-2" Core)	



### Metal Crank Roll Towel Dispenser Model: TD0185

Model #	Color
TD0185-17	White
<b>Width:</b> 8-1/4"	<b>Height:</b> 11-1/2" <b>Depth:</b> 9"
<b>Weight:</b> 9 lbs	<b>Key Type:</b> 1
<b>Capacity:</b> Roll Towel 8"-9-1/2" W & 8" D, (any core size)	



### Self-Adjusting Centerpull Roll Towel Dispenser Model: TD0255

Model #	Color
TD0255-01	Dark Translucent
TD0255-02	Black Translucent
<b>Width:</b> 10-1/4"	<b>Height:</b> 12-1/4" <b>Depth:</b> 10-1/4"
<b>Weight:</b> 3.5 lbs	<b>Key Type:</b> 1
<b>Capacity:</b> Roll Towel 9" W & 9" D (maximum size)	



**Multifold/C-Fold Towel Dispenser** Model: TD0170

Model #	Color	
TD0170-17	White	
TD0170-13	Brushed Steel	
TD0170-12	Bright Chrome	
<b>Width: 11-1/4"</b>	<b>Height: 15-1/4"</b>	<b>Depth: 3-3/4"</b>
<b>Weight: 6.33 lbs</b>	<b>Key Type: 1</b>	
<b>Capacity: 540 Multifold or 350 C-Fold Towels</b>		



**Multifold/C-Fold Towel Dispenser** Model: TD0175

Model #	Color	
TD0175-01	Dark Translucent	
TD0175-03	White Translucent	
<b>Width: 11-1/4"</b>	<b>Height: 15-1/4"</b>	<b>Depth: 5"</b>
<b>Weight: 5 lbs</b>	<b>Key Type: 1</b>	
<b>Capacity: 540 Multifold or 350 C-Fold Towels</b>		



**Plastic Multifold Towel Dispenser** Model: TD0179

Model #	Color	
TD0179-01	Dark Translucent	
TD0179-02	Black Translucent	
TD0179-03	White Translucent	
<b>Width: 11"</b>	<b>Height: 16"</b>	<b>Depth: 4-1/2"</b>
<b>Weight: 2.17 lbs</b>	<b>Key Type: 1</b>	
<b>Capacity: 540 Multifold or 350 C-Fold Towels</b>		



**ExiTowel Mini-Fold Towel Dispenser** Model: TD0177

Model #	Color	
TD0177-02	Dark Translucent	
TD0177-02	Black Translucent	
TD0178-01	Dark Translucent Starter Pack	
TD0178-02	Black Translucent Starter Pack	
<b>Width: 5-1/2"</b>	<b>Height: 11-1/4"</b>	<b>Depth: 4"</b>
<b>Weight: 2 lbs</b>	<b>Key Type: 1</b>	
<b>Capacity: 500 Mini-Fold Towels</b>		



**Metal Singlefold Towel Dispenser** Model: TD0091

Model #	Color	
TD0091-17	White	
<b>Width: 11-3/4"</b>	<b>Height: 9-3/4"</b>	<b>Depth: 5-3/4"</b>
<b>Weight: 4.5 bs</b>	<b>Key Type: 1</b>	
<b>Capacity: 450 Singlefold Towels</b>		



# Products for YOUR Market

Palmer Fixture knows that the Jan-San Market is far reaching. We want to help meet your needs wherever our product may be going!  
Call us today at 800.558.8678 and we'll help move your project forward.





**Stainless Twin 9" Jumbo Roll Tissue Dispenser** Model: RD0327

Model #	Color
RD0327-09	Brushed Stainless

**Width:** 20-1/4" **Height:** 11-3/4" **Depth:** 5-1/2"  
**Weight:** 7.75 lbs **Key Type:** 1  
**Capacity:** Two 9" Rolls (2-1/4"-3-3/8" Core)



**Twin 9" Jumbo Roll Tissue Dispenser** Model: RD0027

Model #	Color
RD0027-01	Dark Translucent
RD0027-02	Black Translucent
RD0027-03	White Translucent
RD0027-01F	Dark Translucent
RD0027-02F	Black Translucent
RD0027-03F	White Translucent

**Width:** 20-1/4" **Height:** 11-1/4" **Depth:** 5-1/2"  
**Weight:** 4.5 lbs **Key Type:** 1  
**Capacity:** Two 9" Rolls (2-1/4"-3-3/8" Core)



**Single 9" Jumbo Roll Tissue Dispenser with Stub Roll** Model: RD0024

Model #	Color
RD0024-01F	Dark Translucent
RD0024-02F	Black Translucent
RD0024-03F	White Translucent

**Width:** 16-1/4" **Height:** 11-1/2" **Depth:** 5-1/4"  
**Weight:** 3 lbs **Key Type:** 1  
**Capacity:** 9" Roll & Stub Roll (2-1/4" w/ 3-3/8" Adaptor)

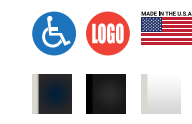

**Single 9" Jumbo Roll Tissue Dispenser** Model: RD0026

Model #	Color
RD0026-01	Dark Translucent
RD0026-02	Black Translucent
RD0026-03	White Translucent
RD0026-01F	Dark Translucent
RD0026-02F	Black Translucent
RD0026-03F	White Translucent

**Width:** 11-1/2" **Height:** 11" **Depth:** 5"  
**Weight:** 2.83 lbs **Key Type:** 1  
**Capacity:** 9" Rolls (2-1/4"-3-3/8" Core)



**Single 10" Jumbo Roll Tissue Dispenser** Model: RD0346

Model #	Color
RD0346-09	Brushed Stainless
RD0346-17	White

**Width:** 10-1/2" **Height:** 10-3/8" **Depth:** 4-1/4"  
**Weight:** 3.66 lbs **Key Type:** 13  
**Capacity:** 10" Roll (1-3/4"-2-1/4")

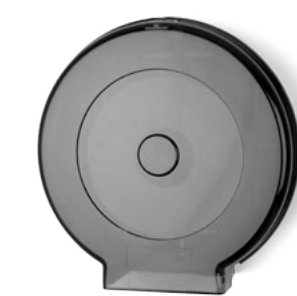

**Single 12" Senior Jumbo Roll Tissue Dispenser** Model: RD0039

Model #	Color
RD0039-02F	Black Translucent

**Width:** 15-1/4" **Height:** 15-1/4" **Depth:** 5-1/4"  
**Weight:** 4.33 lbs **Key Type:** 1  
**Capacity:** 12" Roll (1-3/4"-3" Core)



**Single 13" Jumbo Roll Tissue Dispenser** Model: RD0330

Model #	Color
RD0330-01	Dark Translucent
RD0330-02	Black Translucent

**Width:** 16-1/4" **Height:** 14-1/2" **Depth:** 5"  
**Weight:** 2.75 lbs **Key Type:** 1  
**Capacity:** 13" Roll (3-3/8" Core)



**Single 14" Jumbo Roll Tissue Dispenser** Model: RD0348

Model #	Color
RD0348-09	Brushed Stainless
RD0348-17	White

**Width:** 14-1/4" **Height:** 14-1/4" **Depth:** 4-1/4"  
**Weight:** 5 lbs **Key Type:** 13  
**Capacity:** 14" Roll (1-3/4"-2-1/4" Core)



**Stainless Two-Roll Standard Roll Tissue Dispenser** Model: RD0325

Model #	Color
RD0325-09	Brushed Stainless
<b>Width:</b> 6"	<b>Height:</b> 13-3/4" <b>Depth:</b> 5-3/4"
<b>Weight:</b> 4.83 lbs	<b>Key Type:</b> 1
<b>Capacity:</b> Two 4-1/2"W x 5-1/4"D Rolls (1-1/2" Core)	



**Stainless Two-Roll Standard Roll Tissue Dispenser** Model: RD0384

Model #	Color
RD0384-12	Bright Chrome
<b>Width:</b> 11-3/4"	<b>Height:</b> 4-1/4" <b>Depth:</b> 2-3/4"
<b>Weight:</b> 1.33 lbs	
<b>Capacity:</b> Two 4-1/2"W x 5-1/4"D Rolls (1-1/2" Core)	



**Stainless Single Roll Standard Tissue Dispenser** Model: RD0381

Model #	Color
RD0381-12	Bright Chrome
<b>Width:</b> 6"	<b>Height:</b> 4-1/4" <b>Depth:</b> 2-3/4"
<b>Weight:</b> .75 lbs	
<b>Capacity:</b> One 4-1/2"W x 5-1/4"D Rolls (1-1/2" Core)	



**Two-Roll Standard Roll Tissue Dispenser** Model: RD0025

Model #	Color
RD0025-01	Dark Translucent
RD0025-03	White Translucent
<b>Width:</b> 6"	<b>Height:</b> 13-1/4" <b>Depth:</b> 5-3/4"
<b>Weight:</b> 3.83 lbs	<b>Key Type:</b> 1
<b>Capacity:</b> Two 4-1/2"W x 5-1/4"D Rolls (1-1/2" Core)	



**4-Roll Carousel Standard Roll Tissue Dispenser** Model: RD0044

Model #	Color
RD0044-01	Dark Translucent
<b>Width:</b> 13-1/2"	<b>Height:</b> 14-3/4" <b>Depth:</b> 6-1/4"
<b>Weight:</b> 4 lbs	<b>Key Type:</b> 2
<b>Capacity:</b> Four 4-1/2"W x 5-1/4"D Rolls (1-1/2" Core)	

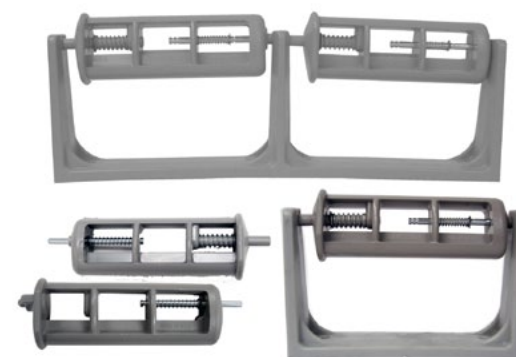

**Governor & No-Waste Single/Double Roll Spindles**

Model # (Single Roll)		Model # (Double Roll)		Model # (Replacement Spindle)	
RD0401-21	RD0404-21	RD0421-21	RD0424-21	RS0201-21	RS0403-21
<b>Width:</b> 6-1/2"	<b>Height:</b> 4-1/2"	<b>Width:</b> 12-1/2"	<b>Height:</b> 4-1/2"	<b>Width:</b> 6-1/2"	<b>Height:</b> 4-1/2"
<b>Depth:</b> 1-3/4"	<b>Weight:</b> .54 lbs	<b>Depth:</b> 1-3/4"	<b>Weight:</b> 1 lbs	<b>Depth:</b> 1-3/4"	
<b>Capacity:</b> One 4-1/2"W x 5-1/4"D Roll		<b>Capacity:</b> Two 4-1/2"W x 5-1/4"D Rolls			



**Two-Roll Standard Roll Tissue Dispenser** Model: RD0028

Model #	Color
RD0028-01	Dark Translucent
RD0028-03	White Translucent
<b>Width:</b> 6"	<b>Height:</b> 13" <b>Depth:</b> 5-3/4"
<b>Weight:</b> 2.16 lbs	<b>Key Type:</b> 1
<b>Capacity:</b> Two 4-1/2"W x 5-1/4"D Rolls (1-1/2" Core)	



**Two-Roll Standard Roll Tissue Dispenser** Model: RD0321

Model #	Color
RD0321-01	Dark Translucent
RD0321-02	Black Translucent
RD0321-03	White Translucent
RD0321-01G	Dark Translucent
RD0321-02G	Black Translucent
RD0321-03G	White Translucent
<b>Width:</b> 11-1/4"	<b>Height:</b> 7" <b>Depth:</b> 5-1/2"
<b>Weight:</b> 2.16 lbs	<b>Key Type:</b> 1
<b>Capacity:</b> Two 4-1/2"W x 5-1/4"D Rolls (1-1/2" Core) "G" Model - Most Micro-Core Tissue up to 5-1/4"D	





**Electronic Impact Resistant Plastic Bulk Soap Dispenser** Model: SE0800-17

Model #	Color
SE0800-17	White
<b>Width:</b> 4-1/2"	<b>Height:</b> 10-1/2" <b>Depth:</b> 4-1/4"
<b>Weight:</b> 2.08 lbs	<b>Key Type:</b> 5
<b>Capacity:</b> 800mL Liquid Soap	



**Electronic Touchless Bulk Soap Dispenser** Model: SE0800-09

Model #	Color
SE0800-09	Brushed Stainless
<b>Width:</b> 4-1/2"	<b>Height:</b> 10-1/2" <b>Depth:</b> 4-1/4"
<b>Weight:</b> 2.83 lbs	<b>Key Type:</b> 4
<b>Capacity:</b> 800mL Liquid Soap	



**46oz Bulk Liquid Soap Dispenser** Model:SD0046

Model #	Color
SD0046-01	Dark Translucent
<b>Width:</b> 5-1/4"	<b>Height:</b> 8-1/2" <b>Depth:</b> 4-1/4"
<b>Weight:</b> 1.50 lbs	
<b>Capacity:</b> 46oz. Liquid Soap	



**30oz Bulk Liquid Soap Dispenser** Model: SD0030

Model #	Color
SD0030-01	Dark Translucent
<b>Width:</b> 4-3/4"	<b>Height:</b> 6-1/4" <b>Depth:</b> 4-1/2"
<b>Weight:</b> .83 lbs	
<b>Capacity:</b> 30oz. Liquid Soap	



# Complete the Family.



# Style to fit your environment!

# Palmer Fixture with the Click of a Mouse.



[www.palmerfixture.com](http://www.palmerfixture.com)



**Electronic Touchless Bulk Foam Soap Dispenser** Model: SE0802

Model #	Color
SE0802-09	Brushed Stainless
<b>Width:</b> 4-3/4"	<b>Height:</b> 10-1/2" <b>Depth:</b> 4-1/4"
<b>Weight:</b> 2.83 lbs	<b>Key Type:</b> 4
<b>Capacity:</b> 800mL Foam Soap	



**Electronic Bulk Foam Soap Dispenser** Model: SF2150

Model #	Color
SF2150-08	Platinum
SF2150-16	Black
SF2150-17	White
<b>Width:</b> 5"	<b>Height:</b> 10-3/4" <b>Depth:</b> 4"
<b>Weight:</b> 2.16 lbs	<b>Key Type:</b> 11
<b>Capacity:</b> 1000mL Foam Soap	



**Manual Bulk Foam Soap Dispenser** Model: SF2111

Model #	Color
SF2111-08	Platinum
SF2111-16	Black
SF2111-17	White
<b>Width:</b> 4-1/2"	<b>Height:</b> 10-1/4" <b>Depth:</b> 4-1/2"
<b>Weight:</b> 1.58 lbs	<b>Key Type:</b> 10
<b>Capacity:</b> 1000mL Foam Soap	



**46oz Bulk Foam Soap Dispenser** Model: SF2144

Model #	Color
SF2144-01	Dark Translucent
<b>Width:</b> 5-1/4"	<b>Height:</b> 8-1/2" <b>Depth:</b> 4-1/4"
<b>Weight:</b> 1.5 lbs	
<b>Capacity:</b> 46oz. Foam Soap	



**30oz Bulk Foam Soap Dispenser** Model: SF2135

Model #	Color
SF2135-01	Dark Translucent
<b>Width:</b> 4-3/4"	<b>Height:</b> 6-1/4" <b>Depth:</b> 4-1/2"
<b>Weight:</b> .83 bs	
<b>Capacity:</b> 30oz. Foam Soap	







**Automatic Sani Suds® Soap & Sanitizer Dispenser** Model: SF0305

Model #	Color
SF0305-01	Dark Translucent
SF0305-02	Black Translucent
SF0305-03	White Translucent
<b>Width: 4-3/4" Height: 11-1/4" Depth: 4-3/4"</b>	
<b>Weight: 2.16 lbs Key Type: 1</b>	
<b>Capacity: One Sani Suds® Soap or Sanitizer Refill</b>	



**Manual Sani Suds® Soap & Sanitizer Dispenser** Model: SF0407

Model #	Color
SF0407-01	Dark Translucent
SF0407-02	Black Translucent
SF0407-03	White Translucent
<b>Width: 4-3/4" Height: 11-1/4" Depth: 4-3/4"</b>	
<b>Weight: 1.66 lbs Key Type: 1</b>	
<b>Capacity: One Sani Suds® Soap or Sanitizer Refill</b>	



**Sani Suds® Floor Stand** Model: SF0300

Model #	Color
SF0300-16	Black
<b>Width: 6" Height: 48" Depth: 14"</b>	
<b>Weight: 8 lbs Base: 14"x14"</b>	
<b>Capacity: One Sani Suds® Dispenser</b>	

**Sani Suds® Tabletop Stand** Model: SF0301

Model #	Color
SF0301-16	Black
<b>Width: 7" Height: 18-3/4" Depth: 6-1/4"</b>	
<b>Weight: 1 lbs</b>	
<b>Capacity: One Sani Suds® Dispenser</b>	



**Green Seal Certified™ Lotion Foam Soap** Model: RP7000

Model #
RP7000-24
<b>Width: 7-1/2" Height: 9" Depth: 2"</b>
<b>Weight: 2.66 lbs Capacity: 1200mL</b>



**E-2 Foam Hand Cleanser Soap** Model: RP7250

Model #
RP7250-23
<b>Width: 7-1/2" Height: 9" Depth: 2"</b>
<b>Weight: 2.66 lbs Capacity: 1200mL</b>



**Alcohol-Free Instant Foam Hand Sanitizer** Model: RP7500

Model #
RP7500-19
<b>Width: 7-1/2" Height: 9" Depth: 2"</b>
<b>Weight: 2.66 lbs Capacity: 1200mL</b>



**Antibacterial Foam Soap with Triclosan** Model: RP7125

Model #
RP7125-18
<b>Width: 7-1/2" Height: 9" Depth: 2"</b>
<b>Weight: 2.66 lbs Capacity: 1200mL</b>



**Green Seal Certified™ Bath & Body Soap** Model: RP7375

Model #
RP7375-00
<b>Width: 7-1/2" Height: 9" Depth: 2"</b>
<b>Weight: 2.66 lbs Capacity: 1200mL</b>



**Alcohol Instant Foam Hand Sanitizer** Model: RP7800

Model #
RP7800-23
<b>Width: 7-1/2" Height: 9" Depth: 2"</b>
<b>Weight: 2.66 lbs Capacity: 1000mL</b>



Liquid Bag-in-the-Box  
800 ml = 27 fl. oz.

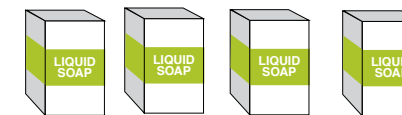

Other Foam  
1100 ml = 37.3 fl. oz.

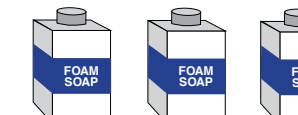

Sani Suds  
1200 ml = 40.5 fl. oz.



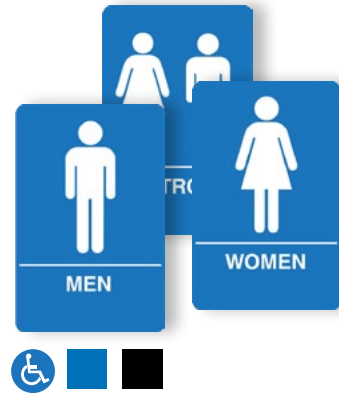

**ADA Restroom Signs**

Model #	Color
IS1001-15	Blue
IS1001-16	Black
IS1003-15	Blue
IS1003-16	Black
IS1005-15	Blue
IS1005-16	Black
<b>Width: 6"</b>	<b>Height: 8"</b>
<b>Depth: 1/4"</b>	<b>Weight: .5 lbs</b>



**ADA Accessible Restroom Signs**

Model #	Color
IS1002-15	Blue
IS1002-16	Black
IS1004-15	Blue
IS1004-16	Black
IS1006-15	Blue
IS1006-16	Black
<b>Width: 6"</b>	<b>Height: 8"</b>
<b>Depth: 1/4"</b>	<b>Weight: .5 lbs</b>



**Employees Must Wash Hands Notice Sign**

Model #	Color
IS8001-15	Blue
IS8001-16	Black
IS8001-18	Green
IS8001-22	Red
<b>Width: 8"</b>	<b>Height: 6"</b>
<b>Depth: 1/4"</b>	<b>Weight: .5 lbs</b>



**Caution Wet Floor Sign** Model: CS0701

Model #	Color
CS0701-19	Yellow
<b>Width: 12"</b>	<b>Height: 24-1/2"</b>
<b>Depth: 15-1/4"</b>	<b>Weight: 2.20 lbs</b>

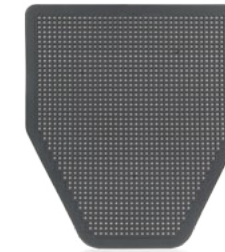

**Disposable Urinal Mat** Model: FM0148

Model #	Color
FM0148-12	Grey
<b>Width: 17-3/4"</b>	<b>Height: 20-1/2"</b>
<b>Depth: 1/4"</b>	<b>Weight: 1.16 lbs</b>



**Auto Spout Adaptor** Model: AF0630

Model #	Color
AF0630-12	Bright Chrome
<b>Width: 3-1/2"</b>	<b>Height: 2-1/2"</b>
<b>Depth: 2"</b>	<b>Weight: 1 lbs</b>



**Disposable Commode Mat** Model: FM0149

Model #	Color
FM0149-12	Grey
<b>Width: 23"</b>	<b>Height: 21-1/4"</b>
<b>Depth: 1/4"</b>	<b>Weight: 1 lbs</b>



**18" & 24" Metal Grab Bar** Model: CS0718 CS0724

Model #	Color
CS0718-09	Brushed Stainless
<b>Width: 21-1/8"</b>	<b>Height: 3-1/8"</b>
<b>Depth: 3-1/8"</b>	<b>Weight: 1.66 lbs</b>

Model #	Color
CS0724-09	Brushed Stainless
<b>Width: 27-1/8"</b>	<b>Height: 3-1/8"</b>
<b>Depth: 3-1/8"</b>	<b>Weight: 2 lbs</b>



**Toilet Seat Cover Dispenser** Model: TS0142

Model #	Color
TS0142-01	Dark Translucent
TS0142-03	White Translucent
<b>Width: 16"</b>	<b>Height: 11-3/4"</b>
<b>Depth: 2-1/2"</b>	<b>Weight: .85 lbs</b>
Model #	Color
TS0142-11	Brushed Chrome
<b>Width: 16"</b>	<b>Height: 11-3/4"</b>
<b>Depth: 2-1/2"</b>	<b>Weight: 3.33 lbs</b>



**Counter Top Low Fold Napkin Dispenser** Model: ND0051

Model #	Color
ND0051-13	Brushed Steel
<b>Width:</b> 4-9/16"	<b>Height:</b> 5-1/2" <b>Depth:</b> 11-3/4"
<b>Weight:</b> 4 lbs	
<b>Capacity:</b> 375 Lowfold Napkins	



**Table Top Tall Fold Napkin Dispenser** Model: ND0031

Model #	Color
ND0031-13	Brushed Steel
<b>Width:</b> 3-5/8"	<b>Height:</b> 7-3/8" <b>Depth:</b> 4-1/8"
<b>Weight:</b> 1.16 lbs	
<b>Capacity:</b> 175 Tallfold Napkins	



**Table Top Low Fold Napkin Dispenser** Model: ND0045

Model #	Color
ND0045-13	Brushed Steel
<b>Width:</b> 4"	<b>Height:</b> 5-1/2" <b>Depth:</b> 4-13/16"
<b>Weight:</b> 1.75 lbs	
<b>Capacity:</b> 180 Lowfold Napkins	



**Counter Top Mini Fold Napkin Dispenser** Model: ND0061

Model #	Color
ND0061-13	Brushed Steel
<b>Width:</b> 7-5/8"	<b>Height:</b> 4-1/2" <b>Depth:</b> 11-5/8"
<b>Weight:</b> 4.66 lbs	
<b>Capacity:</b> 300 Minifold Napkins	



**Table Top Mini Fold Napkin Dispenser** Model: ND0055

Model #	Color
ND0055-13	Brushed Steel
<b>Width:</b> 7-1/2"	<b>Height:</b> 4-1/2" <b>Depth:</b> 6"
<b>Weight:</b> 2.66 lbs	
<b>Capacity:</b> 200 Minifold Napkins	



**Table Top Full Fold Napkin Dispenser** Model: ND0065

Model #	Color
ND0065-13	Brushed Steel
<b>Width:</b> 7-1/2"	<b>Height:</b> 5-3/4" <b>Depth:</b> 6-1/4"
<b>Weight:</b> 3.08 lbs	
<b>Capacity:</b> 200 Fullfold Napkins	



**Counter Top Full Fold Napkin Dispenser** Model: ND0071

Model #	Color
ND0071-13	Brushed Steel
<b>Width:</b> 7-5/8"	<b>Height:</b> 5-1/2" <b>Depth:</b> 11-11/16"
<b>Weight:</b> 5.16 lbs	
<b>Capacity:</b> 300 Fullfold Napkins	



## Keys

For more information on Replacement Keys, visit [www.palmerfixture.com](http://www.palmerfixture.com) or call **1-800-558-8678**. Please reference the individual product information tables to see which key fits a specific dispenser.

1 SP0100-00



2 SP0102-00



3 SP0103-00



4 SP0104-00



5 SP0105-00



6 SP0106-00



7 SP0101-00



8 SP0108-00



9 SP0107-00



10 SP0110-00



11 SP0111-00



13 SP0113-00



## Replacement Dispenser Parts

Replacement parts are available for most Palmer Fixture dispensers, please call **1.800.558.8678** for replacement part information.

**For Questions, Customer Service,  
Product or Warranty Information,  
Please Call: 800.558.8678**

## NOTES:

---

---

---

---

---

---

---

---

**Phone:** 920.884.8698  
**Toll-Free:** 800.558.8678  
**Fax:** 920.884.8699  
**Email:** [info@palmerfixture.com](mailto:info@palmerfixture.com)  
**Website:** [www.palmerfixture.com](http://www.palmerfixture.com)

**Mailing Address:**  
Palmer Fixture  
PO BOX 10887  
Green Bay, WI 54307

**Connect with Us!**



## Company Information

Palmer Fixture, for over 100 years, has been committed to providing the most competitive value-added dispensing systems available. Palmer Fixture offers a variety of items from the traditional metal crank dispensers to our innovative automatic touchless dispensers and hand dryers. We are constantly expanding our product lines as we continue looking for more ways to satisfy our customers. Most of our products are made in the USA and are subject to strict quality control processes. Through extensive research and development, Palmer Fixture Company has maintained a world wide reputation for product excellence since 1907.

At Palmer Fixture, we are devoted to providing you with a number of solutions based on your specific needs, along with our product offerings and expertise. As we continue to serve as a leader of the industry, we are continuously working on new products and ways to make your life cleaner, greener, and more hygienic.

Palmer Fixture • Phone: 800.558.8678 • Email: [info@palmerfixture.com](mailto:info@palmerfixture.com) • [www.palmerfixture.com](http://www.palmerfixture.com)

**Phone:** 920.884.8698  
**Toll-Free:** 800.558.8678  
**Fax:** 920.884.8699  
**Email:** info@palmerfixture.com



Palmer Fixture  
PO BOX 10887  
Green Bay, WI 54307  
**Website:** www.palmerfixture.com

DISTRIBUTED BY