

# PROFESSIONAL CLEANING SYSTEMS



# UNGER

Quality Tools for Smart Cleaning™



## Check Out Unger's New Website!

Explore Unger's complete line of professional, high quality cleaning supplies online!

Whether looking for tips on cleaning tasks or more information on a specific product, ungerglobal.com is the perfect resource for cleaning professionals.

- Easily find any Unger product or specification by searching product category and solution filters
- Explore our comprehensive Online Resource Center, where you'll find a wide variety of downloadable catalogs, manuals, safety data sheets and how-to videos
- Evaluate short and long term savings with our online ROI Calculator
- Instantly locate Unger suppliers throughout the US and Canada using our advanced Distributor Look-Up Tool
- Improve value and efficiency by accessing helpful, how-to information about the most effective ways to use Unger products

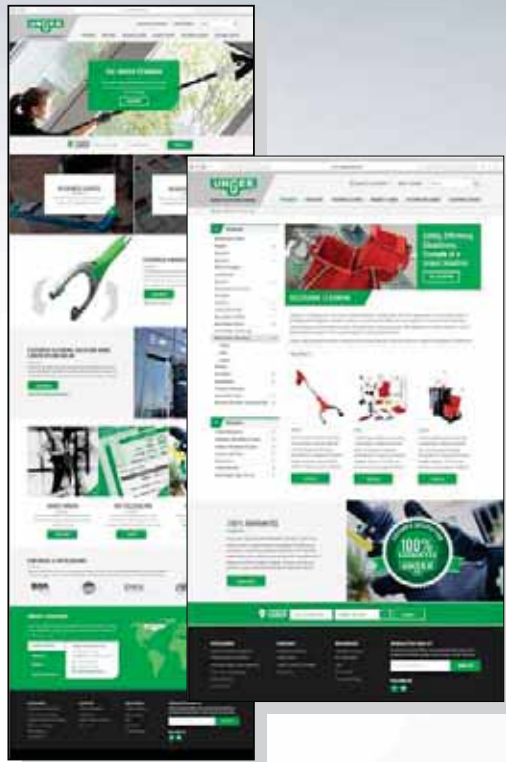

## 100% Satisfaction Guarantee

We design and build our tools to be tougher than the dirt they clean. We stand behind everything we make, 100%.

If for any reason you're not satisfied with an Unger tool, please return it to us within two years of purchase and we'll make it right.

### Here's How:

Mail the item back to us at the address listed below along with a completed 100% Satisfaction Guarantee Form.

Unger Enterprises, LLC  
Attn: Customer Satisfaction  
425 Asylum Street  
Bridgeport, CT 06610

We will replace the item with a comparable item based on style, functionality, and price. Please allow 4-6 weeks for processing. To help ensure fairness to all customers, we do require a receipt in certain situations. Please see our Special Conditions for details.

### Special Conditions

To help protect our customers and make sure every return or exchange is dealt with fairly, in certain situations we may either require a receipt or decline a return or exchange, including:

- We can't accept items for return that were not purchased directly from an Unger authorized distributor.
- If an item has a missing label or it has been defaced, we can't accept it for return without a receipt because we can't be certain it was purchased directly from an Unger authorized distributor.
- On rare occasions we may find it necessary to require a receipt for returns and exchanges based on the nature of prior transactions.
- For the safety of our employees, we can't accept items that have been soiled or contaminated until they have been cleaned.
- Normal wear and tear is not covered by the guarantee.

### Questions?

Email us at: unger@ungerglobal.com or call Customer Service at: 1.800.431.2324

# Table of Contents

## Window Cleaning

Page **4**

HydroPower™ PureWater Kits  
HiFlo™ nLite® Waterfed Poles  
Squeegees, T-Bars & Sleeves  
Scrapers & Accessories  
Chemicals, Cloths & Buckets  
Tool Holders



## Indoor Glass Cleaning

Page **26**

Stingray Cleaning Kits  
SpeedClean™ Window Kits  
Pro Window Cleaning Kits  
Cleaning Accessories



## Dusting and High Access Cleaning

Page **32**

MicroWipe™ Microfiber Cloth  
Microfiber Dusting Tools  
Bulb Changing Tools & Tool Adapters  
Telescopic Poles



## Surface and Floor Care

Page **40**

Dual Bucket System  
Restroom Cleaning  
Floor Mopping  
Floor Scrapers  
Handles  
Floor Squeegees



## Litter Removal

Page **63**

NiftyNabber® Trigger Grip  
NiftyNabber® Pro  
People's Paper Picker Pin  
NiftyNabber® Bagger  
Neoprene Gloves



Spare Parts & Accessories Page **64**

Product Index Page **71**

# Window Cleaning

At Unger, the window cleaning industry is both where the company started and where we continue to be a world leader. Starting with founder Henry Unger's desire to create a better squeegee, Unger has built a reputation of creating the highest quality, most innovative tools available.

Products such as the HydroPower line of pure water production systems demonstrate that today, and moving forward, quality and innovation remain core values of Unger.

PureWater Cleaning

HydroPower™  
PureWater Kits

HiFlo™ nLite®  
Waterfed Poles

HiFlo™ nLite® Kits  
& Accessories

T-Bars & Sleeves

Glass Squeegees  
& Accessories

Scrapers &  
Accessories

Chemicals,  
Cloths, Buckets  
& Tool Holders

Spare Parts

6

8

11

12

16

18

21

24

65

# PureWater Cleaning

# HYDROPOWER®

## Cleaning with PureWater

Pure water is tap water that has been stripped of naturally occurring minerals. The minerals in the water are measured using total dissolved solids (TDS).

Once the minerals are removed (a process known as deionization), the water dries spot-free leaving surfaces professionally clean without the use of chemical additives.



Deionizing water in a portable and cost effective way can be a challenge. Car washes use pure water systems to rinse a car clean, but these systems are large and not suitable for window cleaning.

The Unger HydroPower systems are designed to be the perfect fit for professional cleaners. Engineered to be portable, easy to operate, and extremely efficient, Unger HydroPower systems are at the cutting-edge of innovation when it comes to pure water for the cleaning industry.

### Surfaces to Clean with PureWater TDS Measurements:

**0-09**

- Transparent Surfaces**
- Windows
  - Glass



**10-40**

- Opaque Surfaces**
- Walls
  - Awnings
  - Signs

The built-in TDS meter allows you to quickly and easily check water quality.



# nLITE® WATERFED POLE SYSTEM

Avoid dangerous ladders with Unger's revolutionary nLite Waterfed Poles! Safely clean upper-story windows from ground level with these strong, lightweight poles that don't compromise on rigidity.

Extension Poles, which include yellow and red visual warnings to prevent unintentional separation, attach easily to Master Poles to reach lengths up to 65'. See why nLite poles are the ultimate in waterfed technology!

Includes euro thread adapter

Master Pole (4 Sections)

Yellow visual warning area to avoid unintentional separation

Extension Pole (2 Sections)

Includes endcap

## The Advantages of Waterfed Poles

### Worker Safety – No ladders needed!

For most applications, the dangerous use of ladders is not necessary – this results in safer working conditions for cleaners.



### PureWater Cleans Without Chemicals

The use of PureWater eliminates the need for harmful cleaning chemicals. This results in a safer, chemical-free workplace for cleaners and no harmful chemicals destroying our environment. Green Cleaning!



### Waterfed Poles Increase ROI Over Lift Rentals

Renting a lift is an expensive recurring cost to get the jobs done. Investment into a HiFlo PureWater System does not incur major additional costs and can be used for years.



### Insourcing vs. Outsourcing Your Cleaning Jobs

With inexpensive operating costs, insourcing your cleaning jobs using the HiFlo PureWater Cleaning Systems has a very attractive cost-saving potential.



# HydroPower™ PureWater Kits

Pure water is the fastest and most efficient way to clean outdoor glass surfaces. With Unger's cutting-edge HydroPower and nLite technologies, there is a pure water cleaning solution for every facility's needs. HydroPower is the most efficient DI pure water system on the market, far exceeding standard efficiency.

HiFlo nLite poles offer a perfect balance of weight and rigidity and our super-light waterfed brushes make quick work of even the toughest buildup. Take advantage of modern technology to get your windows spotless today!

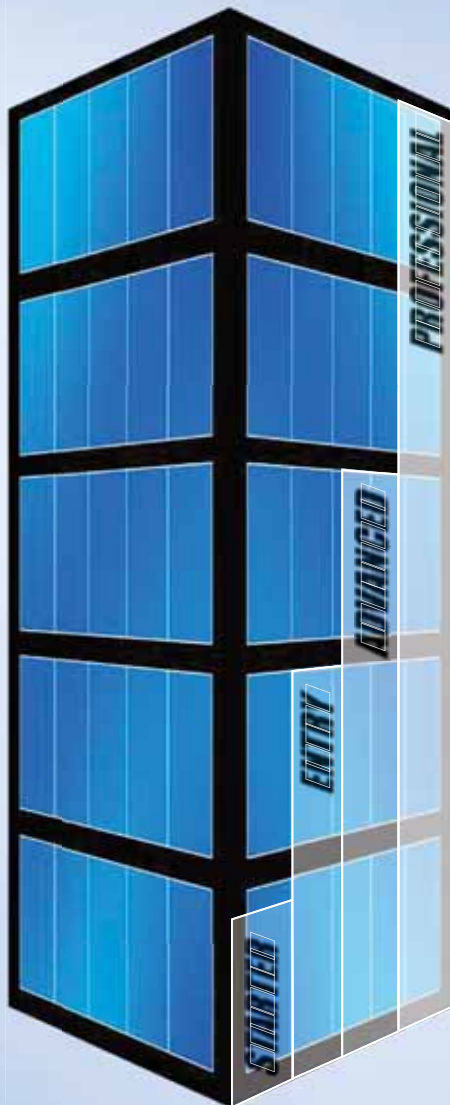

### HydroPower Professional 55' Kit

PART NO.: **HPNL3** CASE QTY.: 1

- Kit Contents:
- HP12C HydroPower Medium Tank, 2 6L Resin Bags, Stainless Steel Cart
- UC67G HiFlo nLite HiMod Carbon Master Pole, 4 Sections - 22'
- UC35G HiFlo nLite HiMod Carbon Extension Pole, 2 Sections - 11' (2)
- CT35G HiFlo nLite Carbon Extension Pole, 2 Sections - 11'
- NLG20 HiFlo nLite MultiLink Gooseneck - 8"
- TMOOV HiFlo Control
- NLHPC HiFlo nLite Hose Brush Connection Kit (2)
- NLBJF HiFlo nLite Fan Jets, Set of 2
- NLR27 HiFlo nLite Radius Brush - 11" (Includes HiFlo nLite Pencil Jets)
- NL25G HiFlo nLite Hose - 82'
- NLBA1 HiFlo nLite Carrying Bag



# 55'

### HydroPower Advanced 33' Kit

PART NO.: **HPNL6** CASE QTY.: 1

- Kit Contents:
- HP12C HydroPower Medium Tank, 2 6L Resin Bags, Stainless Steel Cart
- UC67G HiFlo nLite HiMod Carbon Master Pole, 4 Sections - 22'
- CT35G HiFlo nLite Carbon Extension Pole, 2 Sections - 11'
- NLG20 HiFlo nLite MultiLink Gooseneck - 8"
- TMOOV HiFlo Control
- NLHPC HiFlo nLite Hose Brush Connection Kit (2)
- NLBJF HiFlo nLite Fan Jets, Set of 2
- NLR27 HiFlo nLite Radius Brush - 11" (Includes HiFlo nLite Pencil Jets)
- NL20G HiFlo nLite Hose - 65'
- NLBA1 HiFlo nLite Carrying Bag



# 33'



### HydroPower Entry 20' Kit

PART NO.: **HPANG6** CASE QTY.: 1

- Kit Contents:
- HP06T HydroPower Small Tank, 1 6L Resin Bag
- AN60G HiFlo nLite Aluminum Master Pole, 4 Sections - 20'
- NL11G HiFlo nLite Hose - 36'
- FTGOS HiFlo MultiLink Adapter
- NL27A HiFlo nLite Rectangular Brush - 11" (Includes HiFlo nLite Pencil Jets)

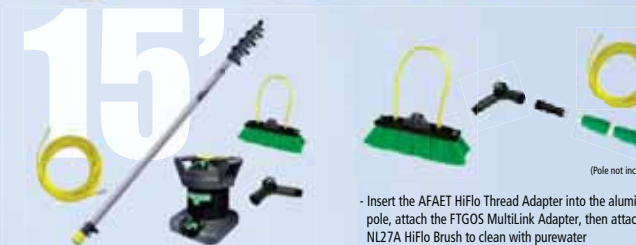

### HydroPower Starter 15' Kit

PART NO.: **HP06K** CASE QTY.: 1

- Kit Contents:
- HP06T HydroPower Small Tank, 1 6L Resin Bag
- AN45G HiFlo nLite Aluminum Master Pole, 4 Sections - 15'
- NL11G HiFlo nLite Hose - 36'
- FTGOS HiFlo MultiLink Adapter
- NLR27 HiFlo nLite Rectangular Brush - 11" (Includes HiFlo nLite Pencil Jets)

(Pole not included)

- Insert the AFAET HiFlo Thread Adapter into the aluminum pole, attach the FTGOS MultiLink Adapter, then attach the NL27A HiFlo Brush to clean with purewater

### PureWater Conversion Kit

PART NO.: **HF40K** CASE QTY.: 1

- Kit Contents:
- AFAET HiFlo™ Euro Thread Adapter
- NL11G HiFlo™ Hose - 36'
- FTGOS HiFlo™ MultiLink Adapter
- NL27A HiFlo™ nLite Rectangular Brush - 11" (Includes HiFlo nLite Pencil Jets)

# HydroPower™ PureWater Systems

## Fastest, Most Effective DI System



HydroPower Quick-Change Resin Bags



### HydroPower 1-Stage

- PART NO.: **HP06T** QTY: 1  
 - Capacity: 300 Gal./1135L  
 - Includes Small Tank, 1 6L Resin Bag

### HydroPower 2-Stage

- PART NO.: **HP12C** QTY: 1  
 - Capacity: 600 Gal./2271L  
 - Includes Medium Tank, 2 6L Resin Bags, Stainless Steel Cart

### PART NO.: **HP12T** QTY: 1

- Capacity: 600 Gal./2271L  
 - Includes Medium Tank, 2 6L Resin Bags

### HydroPower 4-Stage

- PART NO.: **HP24C** QTY: 1  
 - Capacity: 1200 Gal./4543L  
 - Includes Large Tank, 4 6L Resin Bags, Stainless Steel Cart

### PART NO.: **HP24T** QTY: 1

- Capacity: 1200 Gal./4543L  
 - Includes Large Tank, 4 6L Resin Bags

## HydroPower Accessories

### Replacement Resin Bags

- PART NO.: **HPB06** CASE QTY: 1 6L Resin Bag w/ Pail  
 PART NO.: **HPB24** CASE QTY: 4 6L Resin Bags w/ Pail  
 PART NO.: **DIB84** CASE QTY: 4 6L Resin Bags (4) in Bag

- Each bag is made of water-permeable material  
 - Contains a pre-portioned amount of Unger high capacity premium grade virgin mixed bed resin  
 - Reusable pail for storage and disposal (HPB06/HPB24)



### Casters for Tank

- PART NO.: **DIWL4** CASE QTY: 1  
 CONTENTS: 4 Casters

- Smooth rolling casters
- Attach to any HydroPower unit for easy transport
- Not for use with cart



# HiFlo™ nLite® Waterfed Poles

**HiMODULUS CARBON** The ultimate in rigidity, super-light pole. Strength of Material: 180 GPa\*



### HiModulus Master Pole

- PART NO.: **UC67G** SECTIONS: 4 QTY: 1  
 - Length: 22' / 6.6m  
 - Weight: 3.3lb / 1.5kg

### HiModulus Extension Pole

- PART NO.: **UC35G** SECTIONS: 2 QTY: 1  
 - Length: 11' / 3.4m  
 - Weight: 1.5lb / 0.7kg

**CARBON** Superior rigidity, lightweight pole. Ultimate Strength of Material: 100 GPa\*



### Carbon Master Pole

- PART NO.: **CT67G** SECTIONS: 4 QTY: 1  
 - Length: 22' / 6.6m  
 - Weight: 3.5lb / 1.6kg

### Carbon Extension Pole

- PART NO.: **CT35G** SECTIONS: 2 QTY: 1  
 - Length: 11' / 3.4m  
 - Weight: 1.8lb / 0.8kg

**HYBRID** Fiberglass/Carbon Composite Pole. Excellent rigidity and value. Strength of Material: 65 GPa\*

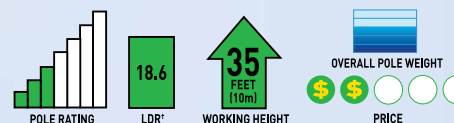

### Hybrid Master Pole

- PART NO.: **HT67G** SECTIONS: 4 QTY: 1  
 - Length: 22' / 6.6m  
 - Weight: 3.7lb / 1.7kg

### Hybrid Extension Pole

- PART NO.: **HT35G** SECTIONS: 2 QTY: 1  
 - Length: 11' / 3.4m  
 - Weight: 2.0lb / 0.9kg

**ALUMINUM** Great quality and value for lower heights. Strength of Material: 30 GPa\*

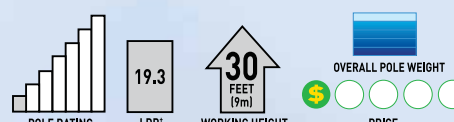

### Aluminum Master Poles

- PART NO.: **AN60G** SECTIONS: 4 QTY: 1  
 - Length: 20' / 6m - Weight: 4.4lb / 2.0kg  
 PART NO.: **AN45G** SECTIONS: 4 QTY: 1  
 - Length: 15' / 4.5m - Weight: 3.6lb / 1.6kg

### Aluminum Extension Pole

- PART NO.: **AN30G** SECTIONS: 2 QTY: 1  
 - Length: 10' / 3m - Weight: 2.4lb / 1.1kg



\*GPa (gigapascal) measure of material stiffness. \*Please refer to [www.ungerglobal.com](http://www.ungerglobal.com) for LDR (Length Deflection Ratio) strength information.

# HiFlo™ nLite® Kits & Accessories



### HiFlo nLite HiMod - 55' Kit

PART NO.: NLKU3 CASE QTY.: 1

**- Kit Contents:**

- UC67G HiFlo nLite HiMod Carbon Master Pole, 4 Sections - 22'
- UC35G HiFlo nLite HiMod Carbon Extension Pole, 2 Sections - 11' (2)
- CT35G HiFlo nLite Carbon Extension Pole, 2 Sections - 11'
- NLG20 HiFlo nLite MultiLink Gooseneck - 8"
- TMOOV HiFlo Control
- NL25G HiFlo nLite Hose - 82'
- NLHPC HiFlo nLite Hose Brush Connection Kit (2)
- NLBJF HiFlo nLite Fan Jets, Set of 2
- NLR27 HiFlo nLite Radius Brush - 11" (Includes HiFlo nLite Pencil Jets)
- NLBA1 HiFlo nLite Carrying Bag

### HiFlo nLite HiMod - 33' Kit

PART NO.: NLKU6 CASE QTY.: 1

**- Kit Contents:**

- UC67G HiFlo nLite HiMod Carbon Master Pole, 4 Sections - 22'
- CT35G HiFlo nLite Carbon Extension Pole, 2 Sections - 11'
- NLG20 HiFlo nLite MultiLink Gooseneck - 8"
- TMOOV HiFlo Control
- NL20G HiFlo nLite Hose - 65'
- NLHPC HiFlo nLite Hose Brush Connection Kit (2)
- NLBJF HiFlo nLite Fan Jets, Set of 2
- NLR27 HiFlo nLite Radius Brush - 11" (Includes HiFlo nLite Pencil Jets)
- NLBA1 HiFlo nLite Carrying Bag



### HiFlo nLite Hybrid Starter Kit - 22'

PART NO.: HTK14 CASE QTY.: 1

**- Kit Contents:**

- HT67G HiFlo nLite Hybrid Master Pole, 4 Sections - 22'
- NL11G HiFlo nLite Hose - 36'
- FTGOS HiFlo MultiLink Adapter
- NL27A HiFlo nLite Rectangular Brush - 11" (Includes HiFlo nLite Pencil Jets)

### HiFlo nLite Aluminum Kit - 20'

PART NO.: AN60K CASE QTY.: 1

**- Kit Contents:**

- AN60G HiFlo nLite Aluminum Master Pole, 4 Sections - 20'
- NL11G HiFlo nLite Hose - 36'
- FTGOS HiFlo MultiLink Adapter
- NL27A HiFlo nLite Rectangular Brush - 11" (Includes HiFlo nLite Pencil Jets)

### HiFlo nLite Prolongation 5' Kit

PART NO.: NLK15 CASE QTY.: 1

**- Kit Contents:**

- NLG15 HiFlo nLite Prolongation Gooseneck - 5'
- FTGOS HiFlo MultiLink Adapter
- NL11G HiFlo nLite Hose - 36'
- NLR27 HiFlo nLite Radius Brush - 11" (Includes HiFlo nLite Pencil Jets)

## nLite Brushes - Light, Strong and Versatile

The HiFlo nLite Brushes allow you to tackle any cleaning challenge with confidence. Choose between various sizes and models depending on the size, type, and angle of the surfaces you're working on. All styles are super-light and feature multiple jet connections and include one set of pencil jets (additional jets available).



### HiFlo nLite Rectangular Brush *Patented*

PART NO.: NL27A	SIZE: 11" / 27cm	CASE QTY.: 1
PART NO.: NL40A	SIZE: 16" / 40cm	CASE QTY.: 1
PART NO.: NL60A	SIZE: 24" / 60cm	CASE QTY.: 1

- Green unsplit bristles for windows and surfaces
- Super-light waterfed brush with multiple jet locations for interchangeable jets
- One set of pencil jets included



### HiFlo nLite Solar Radius Brush *Patented*

PART NO.: NL27Y	SIZE: 11" / 27cm	CASE QTY.: 1
PART NO.: NL40Y	SIZE: 16" / 40cm	CASE QTY.: 1
PART NO.: NL60Y	SIZE: 24" / 60cm	CASE QTY.: 1

- Yellow unsplit bristles designed to clean solar panels
- Super-light waterfed brush with multiple jet locations for interchangeable jets
- One set of pencil jets included



### HiFlo nLite Radius Brush *Patented*

PART NO.: NLR27	SIZE: 11" / 27cm	CASE QTY.: 1
PART NO.: NLR40	SIZE: 16" / 40cm	CASE QTY.: 1

- Radius shape for larger surfaces and angled bristles for sills
- Super-light waterfed brush with multiple jet connections for interchangeable jets
- One set of pencil jets included



### HiFlo nLite Boar's Hair Brush *Patented*

PART NO.: NLE27	SIZE: 11" / 27cm	CASE QTY.: 1
PART NO.: NLE40	SIZE: 16" / 40cm	CASE QTY.: 1

- Natural bristle brush for tough dirt
- Super-light with multiple jet connections for interchangeable jets
- One set of pencil jets included

## nLite Brushes – Special Features

Glass is divided into two categories:



### Hydrophobic Glass

- Water repellent



Use Fan Jets for Hydrophobic Glass



### Hydrophilic Glass

- Attracts water

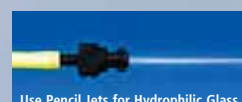

Use Pencil Jets for Hydrophilic Glass

# HiFlo™ nLite® Accessories

## Goosenecks

### HiFlo nLite MultiLink Gooseneck

PART NO.: **NLG20** SIZE: 8"/20cm CASE QTY: 1

PART NO.: **NLG30** SIZE: 12"/30cm CASE QTY: 1

- Ultra-light carbon fiber gooseneck
- Achieve any working angle
- Keeps weight to a minimum
- Includes HiFlo™ nLite Euro Thread Adapter for brush attachment (AFAET)

### HiFlo MultiLink Gooseneck

PART NO.: **FTMGL** SIZE: 19-3/4"/50cm CASE QTY: 1

- Aluminum angle adapter
- Hard anodized aluminum, secure connection
- Brush can be locked in any position through 360°, creating the perfect working angle



### HiFlo nLite Prolongation Gooseneck - 5'

PART NO.: **NLG15** SIZE: 5'/1.52m CASE QTY: 1

- Ultra-light carbon/fiberglass gooseneck
- Includes HiFlo™ nLite thread adapter for brush attachment and adjustable angle adapter

### HiFlo MultiLink Extension

PART NO.: **FTPLS** SIZE: 9-3/4"/25cm CASE QTY: 1

- Aluminum extension adapter
- Hard anodized aluminum, secure connection
- Extend the MultiLink Gooseneck to reach farther
- Can be combined with all MultiLink Goosenecks

## Euro Thread Adapters

### HiFlo MultiLink Adapter

PART NO.: **FTGOS** CASE QTY: 1

- Plastic angle adapter with screw adjustment
- Simple to adjust
- Fits all nLite Brushes and euro thread accessories

### HiFlo MultiLink Cone Adapter

PART NO.: **FTLCA** CASE QTY: 1

- Euro thread to ErgoTec® Locking Cone adapter
- Hard anodized aluminum, secure connection

### HiFlo nLite® MultiLink Thread Adapter

PART NO.: **FTTHR** CASE QTY: 1

- Fits all nLite Brushes and euro thread accessories
- Designed with a hole to lead a hose out of the pole toward the brush
- Made of POM (plastic polymer)

### HiFlo MultiLink Y-Adapter

PART NO.: **FTYAD** CASE QTY: 1

- Attach two tools to one pole
- Solid anodized aluminum
- Fits on all nLite and Unger Telescopic poles (with euro thread adapter)
- Quick tool change by turning the pole

## Hoses & Accessories

### HiFlo nLite Hose

PART NO.: **NL11G** LENGTH: 36'/11m CASE QTY: 1

PART NO.: **NL20G** LENGTH: 65'/20m CASE QTY: 1

PART NO.: **NL25G** LENGTH: 82'/25m CASE QTY: 1

- Quick connect hose adapter
- High-pressure nylon hose

### HiFlo nLite Hose Brush Connection Kit

PART NO.: **NLHPC** CASE QTY: 1

- Connects two jets to the brush
- Two hose pieces and one T-piece

### HiFlo Control

PART NO.: **TMOOV** CASE QTY: 1

- Simple operation - turn water flow to the nLite brush completely on/off or adjust as needed
- Adaptable to any hose or pole diameter
- Easy to install - no hose cutting
- Use with internal and external hoses
- Includes velcro adapter for other pole sizes

### HiFlo nLite Quick Connection Hose Kit

PART NO.: **NLQKI** CASE QTY: 1

- For quick connection of two hoses
- Kit includes: Two Hose end pieces and one Quick Connector

### HiFlo nLite Jets

PART NO.: **NLBJP** TYPE: Pencil  
CONTENTS: Set of 2 Jets CASE QTY: 1

PART NO.: **NLBJF** TYPE: Fan  
CONTENTS: Set of 2 Jets CASE QTY: 1

- For quick connection on nLite® Brushes
- Use Pencil Jets on hydrophilic glass. Great for spraying water to get a constant film
- Use Fan Jets on hydrophobic glass. Great for rinsing and removing dirt with pressure

# Extend Your Reach with nLite

Add tools to any nLite Master pole to reach new heights!

Monsoon Plus Stripwisher® Complete

VisaVersa®

ErgoTec® Ninja Squeegee

ErgoTec® Squeegee

ErgoTec® Ninja Scraper

HiFlo nLite Locking Cone Adapter (See page 2 for more information)

FTTHR MultiLink Thread Adapter (Included with nLite pole)

MultiLink Adapter

Aluminum Pad Holder

Microfiber Washing Pad

Microfiber Cleaning Pad

Scrub Pad

CONE ADAPTER

EURO THREAD

By attaching an appropriate Unger adapter, you can expand the cleaning performance of a nLite pole. Clean windows and glass "Inside and Out" all year round!

nLite Poles Extend Up to 55'

For information about Dusting and High Access tool attachments, turn to page 34.



# T-Bars & Sleeves

### ErgoTec® Ninja Washer Complete

PART NO.: NA350	SIZE: 14"/35cm	CASE QTY.: 5
PART NO.: NA450	SIZE: 18"/45cm	CASE QTY.: 5

- Superior water retention and cleaning
- Built-in microfiber scrubbing bristles with center lock
- Two abrasive pads provide extra scrubbing power
- Ergonomic swivel handle.
- Wash Cycles: 500



**ERGOtec® NINJA**



### Micro StripWasher® Complete

PART NO.: NC350	SIZE: 14"/35cm	CASE QTY.: 10
PART NO.: NC450	SIZE: 18"/45cm	CASE QTY.: 10

- Microfiber sleeve absorbs up to six times its weight
- Scrub pad provides extra cleaning power
- Lightweight plastic T-bar with patented water wells for high water retention, reducing number of bucket dips
- Wash Cycles: 500

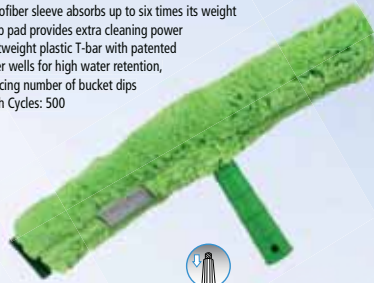

### Monsoon Plus StripWasher® Complete

PART NO.: MC350	SIZE: 14"/35cm	CASE QTY.: 10
PART NO.: MC450	SIZE: 18"/45cm	CASE QTY.: 10

- Woven fabric holds large amounts of water
- Reinforced sewn ends & durable backing for extended life
- Ideal for cleaning large windows/areas
- T-bar with water wells included

### The Original StripWasher® Complete

PART NO.: WC250	SIZE: 10"/25cm	CASE QTY.: 10
PART NO.: WC350	SIZE: 14"/35cm	CASE QTY.: 10
PART NO.: WC450	SIZE: 18"/45cm	CASE QTY.: 10

- Gentle but strong
- Reinforced zigzag stitched ends ensure long life
- Excellent for cleaning windows, screens and dusting
- T-bar with water wells included

### The Pad StripWasher® Complete

PART NO.: RC350	SIZE: 14"/35cm	CASE QTY.: 10
PART NO.: RC450	SIZE: 18"/45cm	CASE QTY.: 10

- Plush, woven synthetic fabric with reinforced zigzag stitching for extended life
- Rough-textured, non-abrasive nylon cleaning pad removes tough dirt
- T-bar with water wells included



### ErgoTec® Ninja T-Bar

PART NO.: NI250	SIZE: 10"/25cm	CASE QTY.: 5
PART NO.: NI350	SIZE: 14"/35cm	CASE QTY.: 5
PART NO.: NI450	SIZE: 18"/45cm	CASE QTY.: 5
PART NO.: NI550	SIZE: 22"/55cm	CASE QTY.: 5
PART NO.: NI750	SIZE: 30"/75cm	CASE QTY.: 5

- Ergonomic T-bar with polypropylene handle
- Two-component handle provides less strain and more control
- Water wells offer increased water retention
- Ergonomic handle with swivel center lock



### ErgoTec® T-Bar

PART NO.: EH250	SIZE: 10"/25cm	CASE QTY.: 10
PART NO.: EH350	SIZE: 14"/35cm	CASE QTY.: 10
PART NO.: EH450	SIZE: 18"/45cm	CASE QTY.: 10

- Ergonomic T-bar with polypropylene handle
- Two-component handle provides less strain and more control
- Water wells create increased water retention

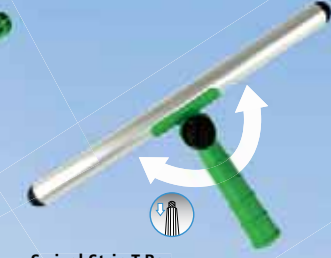

### Swivel Strip T-Bar

PART NO.: SV350	SIZE: 14"/35cm	CASE QTY.: 5
PART NO.: SV450	SIZE: 18"/45cm	CASE QTY.: 5

- Lightweight aluminum T-bar with adjustable head
- Angle adjusts to seven different positions
- Usable with all Unger washer sleeves and telescopic poles



### ErgoTec® Ninja Sleeve

PART NO.: NJ250	SIZE: 10"/25cm	CASE QTY.: 5
PART NO.: NJ350	SIZE: 14"/35cm	CASE QTY.: 5
PART NO.: NJ450	SIZE: 18"/45cm	CASE QTY.: 5
PART NO.: NJ550	SIZE: 22"/55cm	CASE QTY.: 5
PART NO.: NJ750	SIZE: 30"/75cm	CASE QTY.: 5

- Extra long fiber: Built-in microfiber scrubbing bristles
- Two abrasive pads: One on each side providing extra scrubbing power
- Wash Cycles: 500



### Micro StripWasher® Sleeve

PART NO.: NS250	SIZE: 10"/25cm	CASE QTY.: 10
PART NO.: NS350	SIZE: 14"/35cm	CASE QTY.: 10
PART NO.: NS450	SIZE: 18"/45cm	CASE QTY.: 10
PART NO.: NS550	SIZE: 22"/55cm	CASE QTY.: 10

- Microfiber washer sleeve with scrub pad and hook and loop fastening
- Can absorb up to six times its weight
- Scrub pad provides extra cleaning power
- Wash Cycles: 500



### Monsoon Plus StripWasher® Sleeve

PART NO.: MS250	SIZE: 10"/25cm	CASE QTY.: 10
PART NO.: MS350	SIZE: 14"/35cm	CASE QTY.: 10
PART NO.: MS450	SIZE: 18"/45cm	CASE QTY.: 10
PART NO.: MS550	SIZE: 22"/55cm	CASE QTY.: 10

- Heavy-duty washer sleeve with extra-long fibers, scrub pad, and hook and loop fastening
- Woven fabric holds large amounts of water. Reinforced sewn ends & durable backing for extended life
- Ideal for cleaning large windows/areas



### The Original StripWasher® Sleeve

PART NO.: WS250	SIZE: 10"/25cm	CASE QTY.: 10
PART NO.: WS350	SIZE: 14"/35cm	CASE QTY.: 10
PART NO.: WS450	SIZE: 18"/45cm	CASE QTY.: 10
PART NO.: WS550	SIZE: 22"/55cm	CASE QTY.: 10

- Standard washer sleeve made with plush, woven synthetic fabric with hook and loop fastening
- Reinforced zigzag stitched ends ensure long life
- Excellent for cleaning windows, screens, and dusting



### The Pad StripWasher® Sleeve

PART NO.: RS350	SIZE: 14"/35cm	CASE QTY.: 10
PART NO.: RS450	SIZE: 18"/45cm	CASE QTY.: 10

- Standard washer sleeve with plush, woven synthetic fabric on front and textured pad strip on back with hook and loop fastening
- Reinforced zigzag stitching for extended life
- Rough-textured, non-abrasive nylon cleaning pad removes tough dirt



## Tool Connections

For a Listing of All Unger Telescopic Poles, Turn to Page 38



### Lock On

Any tool with a hole in the handle and "LOCK" inscribed on it locks onto the ErgoTec® Locking Cone preventing the tool from twisting or pulling off the pole during work.



### Press On

Special grooves on the cone ensure a secure fit for the tools.



### Screw On

These tools screw onto the ACME thread of an Unger cone.



### Snap On

These tools snap directly onto Unger telescopic poles.

# Glass Squeegees & Accessories



Get a sparkling clean finish faster than ever with Unger's line of pro squeegees. These lightweight, ergonomic squeegees feature two sharp rubber edges for streak-free cleaning. Safety features hold squeegees firmly in place when used with Unger's telescopic poles (see page 38).

Rubber removes quickly for easy replacement. Keep your windows spotless with the Unger Squeegees!



## ErgoTec® Ninja Squeegee Complete

PART NO. EN300	SIZE: 12"/30cm	CASE QTY: 5
PART NO. EN350	SIZE: 14"/35cm	CASE QTY: 5
PART NO. EN450	SIZE: 18"/45cm	CASE QTY: 5

- The most advanced squeegee ever built
- Swivel and TriLoc safety function
- Extruded Aircraft Aluminum T6 Channel is lightweight and will not bend
- Center position can be locked by pressing the Lock Button
- 40° Head Angle

## ErgoTec® Ninja Squeegee Handle - 40°

PART NO. EN000	CASE QTY: 5
----------------	-------------

## ErgoTec® Ninja Squeegee Handle - 30°

PART NO. E3000	CASE QTY: 5
----------------	-------------

- Ergonomic two-component handle with a 40° or 30° head angle, perfect for use with pole
- Swivel and TriLoc safety function for secure channel hold
- Center position can be locked by press of a button



## ErgoTec® Ninja Aluminum Channels

PART NO. AC200	SIZE: 8"/20cm	CASE QTY: 5
PART NO. AC250	SIZE: 10"/25cm	CASE QTY: 5
PART NO. AC300	SIZE: 12"/30cm	CASE QTY: 5
PART NO. AC350	SIZE: 14"/35cm	CASE QTY: 5
PART NO. AC450	SIZE: 18"/45cm	CASE QTY: 5
PART NO. AC550	SIZE: 22"/55cm	CASE QTY: 5
PART NO. AC650	SIZE: 26"/65cm	CASE QTY: 5
PART NO. AC920	SIZE: 36"/92cm	CASE QTY: 5

- Channel is constructed from aircraft-grade aluminum; will not break or bend
- Features laser-etched star markings to make finding the center position easy when attaching to handle
- Flexible rubber positioning allows for a lower position (for shorter channels) and a higher position (for longer channels)
- Comes complete with revolutionary soft rubber "SmartClip" end clips that eliminate the need for separate brass or plastic clips



## ErgoTec® Ninja End Clips

PART NO. PPLUG	CASE QTY: 5 Sets
CONTENTS: End Clip Set (Left & Right)	

- Left and right SmartClip in one set
- Replacement end clips for adjustable rubber tension
- Easily changeable and protects the window frame
- Color signal when clip is open

## ERGO TEC® NINJA The Most Advanced Window Squeegee Ever Built!



**Aircraft Aluminum T6 Channel**  
Lightweight and stable Extruded Aircraft Aluminum T6 channel construction available in lengths up to 36" for cleaning large glass areas. Perfect pressure distribution. Will not break or bend.



**Flexible Rubber Positioning**  
Choose from two rubber positions. Lower position for shorter channels (1), higher position for longer channels (2). Each always has the right pressure and contact to the window.



**Revolutionary End Clip Design**  
Designed to protect window frames from scratching, SmartClips can be easily be replaced by hand or with screw driver.

## ErgoTec® Squeegee Complete

PART NO. ES150	SIZE: 6"/15cm	CASE QTY: 10
PART NO. ES250	SIZE: 10"/25cm	CASE QTY: 10
PART NO. ES300	SIZE: 12"/30cm	CASE QTY: 10
PART NO. ES350	SIZE: 14"/35cm	CASE QTY: 10
PART NO. ES400	SIZE: 16"/40cm	CASE QTY: 10
PART NO. ES450	SIZE: 18"/45cm	CASE QTY: 10
PART NO. ES550	SIZE: 22"/55cm	CASE QTY: 10

- Ergonomic, two-component handle
- Complete with "S" Channel and ErgoTec® Soft Rubber
- Non-slip grip ideal for all weather conditions
- Quick-release "S" spring for fast rubber change



ErgoTec® Squeegee Complete

## Pro Stainless Steel Squeegee Complete

PART NO. PR250	SIZE: 10"/25cm	CASE QTY: 10
PART NO. PR300	SIZE: 12"/30cm	CASE QTY: 10
PART NO. PR350	SIZE: 14"/35cm	CASE QTY: 10
PART NO. PR400	SIZE: 16"/40cm	CASE QTY: 10
PART NO. PR450	SIZE: 18"/45cm	CASE QTY: 10

- Stainless steel squeegee with ergonomic rubber grip
- Complete with "S" Channel and ErgoTec® Soft Rubber
- Non-slip rubber grip ideal for all weather conditions
- Features a fast lock for quick channel changes



Pro Stainless Steel Squeegee Complete

## GoldenClip® Brass Squeegee Complete

PART NO. GS250	SIZE: 10"/25cm	CASE QTY: 10
PART NO. GS300	SIZE: 12"/30cm	CASE QTY: 10
PART NO. GS350	SIZE: 14"/35cm	CASE QTY: 10
PART NO. GS400	SIZE: 16"/40cm	CASE QTY: 10
PART NO. GS450	SIZE: 18"/45cm	CASE QTY: 10

- Complete with handle, channel, ErgoTec soft rubber, and plastic end clips
- Classic brass squeegee with screw lock to firmly hold channel and rubber



GoldenClip® Brass Squeegee Complete

## UniTec™ Lite Squeegee

PART NO. US300	SIZE: 12"/30cm	CASE QTY: 10
----------------	----------------	--------------

- Ultra-light plastic squeegee for glass or flat surfaces in household areas
- Lightweight and comfortable to hold



UniTec™ Lite Squeegee

## VisaVersa®

PART NO. VP250	SIZE: 10"/25cm	CASE QTY: 10
PART NO. VP350	SIZE: 14"/35cm	CASE QTY: 10
PART NO. VP450	SIZE: 18"/45cm	CASE QTY: 10

- Squeegee and washer in one comes pre-assembled
- Complete with "S" Channel, Original StripWasher Sleeve and ErgoTec® Soft Rubber
- Channel and blade are easy to change with quick-release spring



VisaVersa®

## Ergo Tile Squeegee

PART NO. EW35G	SIZE: 14"/35cm	CASE QTY: 10
----------------	----------------	--------------

- Cleans and dries tile and grout lines as well as uneven surfaces
- 14" wide dual blade is soft white moss rubber
- No streaks on light tiles
- Ergonomic handle for comfort

## Auto Squeegee

PART NO. AUSQ0	SIZE: 8"/20cm	CASE QTY: 20
----------------	---------------	--------------

- Squeegee and scrubber in one
- Heavy-duty mesh scrubber for the hard-to-remove buildup on windows
- 24" plastic handle for extended reach



Ergo Tile Squeegee

# Glass Squeegees & Rubber



### ErgoTec® Squeegee Handle

PART NO.: ETG00 CASE QTY: 10

- Ergonomic, two-component handle is a comfortable, non-slip rubber grip that is ideal for all weather conditions.
- Simple, quick-release "S" spring for fast rubber change



### ErgoTec® XL Handle

PART NO.: ETX00 CASE QTY: 10

- Extra long, two-component ergonomically designed handle.
- Handle is almost a full inch longer for large hands
- Quick-release "S" spring for fast rubber change



### ErgoTec® SwivelLoc

PART NO.: LA000 ANGLE: 30° CASE QTY: 5  
PART NO.: LS000 ANGLE: Straight 0° CASE QTY: 5

- Handle comes in two models, both with swivel action and ergonomic grip
- 0° for cleaning low windows.
- 30° head angle for working above ledges
- 0° - Brass or Stainless Steel "S" Channel, 30° - "S" Channel



### Pro Squeegee Handle

PART NO.: PR000 CASE QTY: 10

- Ergonomic, non-slip rubber grip that is ideal for all weather conditions.



### GoldenClip® Brass Handle

PART NO.: GS000 CASE QTY: 10

- Classic solid brass handle with screw locks
- For use with the Brass Channel or "S" Channel



### "S" Channel

PART NO.: NE150 SIZE: 6"/15cm CASE QTY: 10  
PART NO.: NE250 SIZE: 10"/25cm CASE QTY: 10  
PART NO.: NE300 SIZE: 12"/30cm CASE QTY: 10  
PART NO.: NE350 SIZE: 14"/35cm CASE QTY: 10

- Stainless steel "S" Channel complete with ErgoTec® Soft Replacement Rubber
- Fits on ErgoTec and Pro Stainless Steel handles



### Brass Channel for GoldenClip®

PART NO.: GC150 SIZE: 6"/15cm CASE QTY: 10  
PART NO.: GC250 SIZE: 10"/25cm CASE QTY: 10  
PART NO.: GC300 SIZE: 12"/30cm CASE QTY: 10  
PART NO.: GC350 SIZE: 14"/35cm CASE QTY: 10  
PART NO.: GC400 SIZE: 16"/40cm CASE QTY: 10  
PART NO.: GC450 SIZE: 18"/45cm CASE QTY: 10  
PART NO.: GC500 SIZE: 22"/55cm CASE QTY: 10

- Sturdy brass channel complete with ErgoTec soft rubber. Includes plastic end clips



### ErgoTec® Soft Rubber - 12 Packs

PART NO.: RT150	SIZE: 6"/15cm	CASE QTY: 12
PART NO.: RT200	SIZE: 8"/20cm	CASE QTY: 12
PART NO.: RT250	SIZE: 10"/25cm	CASE QTY: 12
PART NO.: RT300	SIZE: 12"/30cm	CASE QTY: 12
PART NO.: RT350	SIZE: 14"/35cm	CASE QTY: 12
PART NO.: RT400	SIZE: 16"/40cm	CASE QTY: 12
PART NO.: RT450	SIZE: 18"/45cm	CASE QTY: 12
PART NO.: RT500	SIZE: 20"/50cm	CASE QTY: 12
PART NO.: RT550	SIZE: 22"/55cm	CASE QTY: 12
PART NO.: RT600	SIZE: 24"/60cm	CASE QTY: 12
PART NO.: RT750	SIZE: 30"/75cm	CASE QTY: 12
PART NO.: RT920	SIZE: 36"/90cm	CASE QTY: 12
PART NO.: RT990	SIZE: 42"/105cm	CASE QTY: 12

- Ideal for cooler temperatures
- Conforms to uneven surfaces
- Better glide with streak-free performance



### ErgoTec® Soft Rubber Gross Packs

PART NO.: RG250	SIZE: 10"/25cm	CASE QTY: 144
PART NO.: RG300	SIZE: 12"/30cm	CASE QTY: 144
PART NO.: RG350	SIZE: 14"/35cm	CASE QTY: 144
PART NO.: RG400	SIZE: 16"/40cm	CASE QTY: 144
PART NO.: RG450	SIZE: 18"/45cm	CASE QTY: 144
PART NO.: RG500	SIZE: 20"/50cm	CASE QTY: 144
PART NO.: RG550	SIZE: 22"/55cm	CASE QTY: 144
PART NO.: RG600	SIZE: 24"/60cm	CASE QTY: 144
PART NO.: RG920	SIZE: 36"/90cm	CASE QTY: 144

- Ideal for cooler temperatures
- Conforms to uneven surfaces
- Sturdy storage box is shrink-wrapped for protection



### Hard Replacement Rubber

PART NO.: RG25H	SIZE: 10"/25cm	CASE QTY: 144
PART NO.: RG35H	SIZE: 14"/35cm	CASE QTY: 144
PART NO.: RG40H	SIZE: 16"/40cm	CASE QTY: 144
PART NO.: RG45H	SIZE: 18"/45cm	CASE QTY: 144
PART NO.: RG55H	SIZE: 22"/55cm	CASE QTY: 144
PART NO.: RG92H	SIZE: 36"/90cm	CASE QTY: 144

- Ideal for warmer temperatures
- Optimum liquid removal on large, flat surfaces
- Coated with talcum to ensure freshness

### Plastic Clips and Case

PART NO.: PCLIP  
CONTENTS: 40 Clips per Dispenser  
CASE QTY: 10



- Increases strength of rubber edge
- Clips easily separate from dispenser
- Solid plastic clip fits between channel and squeegee rubber
- Increases stability, offering sharper end strokes

# Glass Scrapers



### ErgoTec® Ninja Scraper Holster

PART NO.: HT150 CASE QTY: 5

### ErgoTec® Ninja Scraper - Combo

PART NO.: ENH10 SIZE: 4"/10cm CASE QTY: 5  
PART NO.: ENH15 SIZE: 6"/15cm CASE QTY: 5

- Lock the Scraper in the Holster in seconds
- The Easy Clip secures the handle in place and prevents it from falling out
- Durable solid plastic holster with stainless steel insert withstands frequent contact with sharp blade and protects the worker from cuts to legs and hands
- Holster is compatible with most 4" - 6" scrapers on the market, flat or angled

# ERGOtec® NINJA System

Use the ErgoTec Ninja Scraper System to get glass and flat surfaces clean fast. With an adjustable working angle from 0-30°, these dual-sided, rust-resistant blades are perfect for every application. Work faster and safer with an ErgoTec Ninja Scraper and Holster combination.

### ErgoTec® Ninja Scraper

PART NO.: EN100 SIZE: 4"/10cm CASE QTY: 5  
PART NO.: EN150 SIZE: 6"/15cm CASE QTY: 5

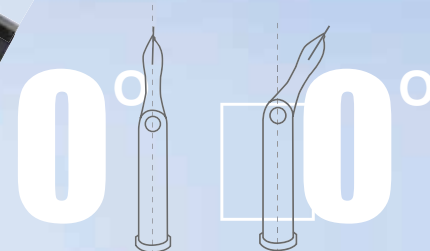

## 2 TOOLS IN 1

The working angle of the scraper head can be changed from 0° for hand scraping to 30° for window scraping with the push of a button!



### Premium Glass Scraper Blades

PART NO.: ENB10 CONTENTS: 25 Blades  
SIZE: 4"/10cm CASE QTY: 10

PART NO.: ENB15 CONTENTS: 25 Blades  
SIZE: 6"/15cm CASE QTY: 10

- Dual-sided sharp blades made from rust resistant 440A grade stainless steel which provides excellent edge retention and ensures that blades stay sharp
- Each blade is honed to a precise edge, creating a perfect cutting angle that is razor sharp and consistent
- Compatible with most 4" and 6" scrapers

# Glass Scrapers



ErgoTec Glass Scraper - 6"

ErgoTec Glass Scraper - 4"

## ErgoTec® Glass Scraper

PART NO. **EG100** SIZE: 4"/10cm CASE QTY: 10  
 PART NO. **EG150** SIZE: 6"/15cm CASE QTY: 10

- Complete with lightweight ergonomic handle and protective cap
- Reversible blade has two razor edges ideal for cleaning large surfaces and scraping off paint, stickers, etc.



## Trim 10 Scraper

PART NO. **TM100** SIZE: 4"/10cm CASE QTY: 10

- Glass scraper in strong stainless steel blade holder.
- Double-edged carbon steel blade
- Fits ErgoTec® and Pro squeegees for window cleaning with telescopic poles



TM100  
Inserted into an ErgoTec Handle

## ProTrim 10 Patented

PART NO.: **TX100** SIZE: 4"/10cm CASE QTY: 10

- Compact scraper for everyday use
- Easily handled, and fits in pocket
- Integrated safety guard for blade protection
- Scraper opens with a push of a button for quick blade replacement and cleaning

## ErgoTec® Safety Scraper & Safety Scraper

PART NO.: **SR040** SIZE: 1-1/2"/4cm CASE QTY: 50

PART NO.: **SR500** SIZE: 1-1/2"/4cm CASE QTY: 50

- Unique locking system eliminates blades from sliding out while working
- Rubber grip on SR040 prevents scraper from slipping in hand
- SR500 made with stainless steel

## Mini Scraper

PART NO. **STMIN** SIZE: 1-1/2"/4cm CASE QTY: 100

- Comes packaged in a storage bucket,
- perfect for countertops
- Easily snaps open for quick blade replacement



# Multi-Surface Scrapers



## Replacement Blades - Carbon Steel

PART NO.: **RB10C** SIZE: 4"/10cm  
 CONTENTS: 10 Dispensers of 10 Blades

PART NO.: **RB30C** SIZE: 4"/10cm  
 CONTENTS: 30 Dispensers of 10 Blades

- Compact handy dispenser safely stores new and used blades – easily slide in and out
- Sharp side for scraping off paint, stickers, etc., and dull side for removing cement and stucco
- For SH00C, SH25C, STMAX



## Replacement Blades - Stainless Steel

PART NO.: **RB100** SIZE: 4"/10cm  
 CONTENTS: 10 Dispensers of 10 Blades

- Compact handy dispenser safely stores new and used blades
- Long-lasting, rust-free blades that easily slide in and out of dispenser
- Sharp side for scraping off paint, stickers, etc., and dull side for removing cement and stucco
- For SH00C, SH25C, STMAX



## Trim/Glass Scraper Replacement Blades

PART NO. **TR100** SIZE: 4"/10cm CONTENTS: 10 Dispensers of 25 Blades  
 PART NO. **TR150** SIZE: 6"/15cm CONTENTS: 10 Dispensers of 25 Blades

- Rust-resistant, coated carbon steel blades with a reversible razor edge
- Handy dispenser protects blades
- Individually wrapped in wax paper to prevent rusting
- For TX100, TM100, EG100/150, EN100/EN150

## Safety Scraper Replacement Blades

PART NO.: **SRBDB** SIZE: 1-1/2"/4cm CONTENTS: 1 Display Box of 48 Dispensers  
 PART NO.: **SRB10** SIZE: 1-1/2"/4cm CONTENTS: 1 tray of 100 Blades  
 PART NO.: **SRB30** SIZE: 1-1/2"/4cm CONTENTS: 10 trays of 100 Blades  
 PART NO.: **SRB40** SIZE: 1-1/2"/4cm CONTENTS: 50 trays of 100 Blades

- Razor sharp No. 9 (1-1/2") standard blades
- Packed in a convenient reclosable plastic tray so blades are kept safe and dry to prevent rusting
- SRBDB: Compact display box for general merchandising areas
- Contains 48 individually packaged dispensers, each dispenser contains 10 blades
- For SR040, SR500, STMIN



## Expert Tips - How Professionals Scrape

- Check if glass is scratch-resistant and suitable for scraper use  
*Unsuitable glass surfaces include: plexiglass, crown glass, solar glass, and safety glass (ESG)*
- Always follow the manufacturer's instructions
- Perform a scrape test in advance on a small section
- Before starting, check the glass for any damage and report it, if necessary
- Check the blade for damage and change or reverse it
- The surface to be scraped should always be wet
- It is best to use a releasing agent, such as EasyGlide Glass Cleaner
- Scrape in one direction. Never pull the scraper back, as this may cause scratches

# Window Cleaning Kits



## ErgoTec® Set

PART NO.: **ETSET** CASE QTY.: 1

### - Kit Contents:

- EH350 ErgoTec® T-Bar - 14"
- NE250 Micro StripWasher® Sleeve - 14"
- ETG00 ErgoTec® Squeegee Handle
- NE250 "S" Channel w/ErgoTec® Soft Rubber - 10"
- NE350 "S" Channel w/ErgoTec® Soft Rubber - 14"
- NE450 "S" Channel w/ErgoTec® Soft Rubber - 18"
- RT920 ErgoTec® Soft Replacement Rubber - 36"
- PCLIP Plastic Clips and Case
- SH00C ErgoTec® Scraper - 4"
- SR500 ErgoTec® Safety Scraper - 1.5"
- MF40L MicroWipe® (3)
- EZ250 OptiLoc® 2-Section Tele-Pole - 8'
- NCANO ErgoTec® Safety Cone
- PL100 The Pill Glass Cleaner (10 pack)
- Nylon Carrying Case



## Tran-Set Cleaning Kit

PART NO.: **TR500** CASE QTY.: 1

### - Kit Contents:

- PR000 Pro Stainless Steel Squeegee Handle
- NE250 "S" Channel w/ErgoTec® Soft Rubber - 10"
- NE350 "S" Channel w/ErgoTec® Soft Rubber - 14"
- NE450 "S" Channel w/ErgoTec® Soft Rubber - 18"
- RT920 ErgoTec® Soft Rubber - 36"
- WC350 Original StripWasher® Complete - 14"
- EZ250 OptiLoc® 2-Section Tele-Pole - 8'
- NCANO ErgoTec® Locking Cone
- FIX10 ErgoTec® FIXI-clamp
- HBR00 HandiBrush
- SP010 Large Sponge
- SR500 ErgoTec® Safety Scraper
- TX100 ProTrim10 Scraper
- Nylon Carrying Case

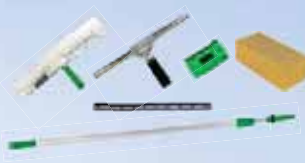

## Pro Window Cleaning Kit

PART NO.: **PWK00** CASE QTY.: 1

### - Kit Contents:

- WC450 Original StripWasher® Complete - 18"
- PR000 Pro Stainless Steel Squeegee Handle
- NE350 "S" Channel w/ErgoTec® Soft Rubber - 14"
- NE450 "S" Channel w/ErgoTec® Soft Rubber - 18"
- TX100 ProTrim10 Scraper
- SP010 Large Sponge
- EZ250 OptiLoc® 2-Section Tele-Pole - 8'

## Chemicals & Cloths

### The Pill Glass Cleaner

PART NO.: **PL100** CONTENTS: 100 Pills CASE QTY.: 1  
PART NO.: **PL500** CONTENTS: 500 Pills CASE QTY.: 1

- Pre-measured, individually packaged, mix with 2½ gallons of water
- Biodegradable, skin friendly and non-toxic

### RubOut

PART NO.: **RUB50** SIZE: 1 Pint CASE QTY.: 12

- Professional surface cleaner for removing hard-water stains, rust, mineral deposits, lime scale and soap scum
- Scrub stains without harming surface

### EasyGlide Glass Cleaner

PART NO.: **FR110** SIZE: 1 Quart CASE QTY.: 6  
PART NO.: **FR380** SIZE: 1 Gallon CASE QTY.: 4

- Liquid window cleaner that leaves behind a smooth surface for squeegees to glide across. 100:1 concentrate (Makes 25 gallons per quart)
- Biodegradable, skin friendly and non-toxic

### MicroWipe™

PART NO.: **MF40L** SIZE: 16" x 16" / 40 x 40cm CASE QTY.: 10  
PART NO.: **MF10L** SIZE: 4" x 4" / 10 x 10cm CASE QTY.: 10

- Ultra-fine microfiber cloth ideal for ledges and frames on windows and mirrors
- Superior water absorption, no streaks
- Two surfaces: coarse for cleaning, smooth for polishing
- Pocket sized cloth perfect for cleaning eye glasses, phone and tablet screens

### Ninja MicroWipe™

PART NO.: **MN40U** SIZE: 16" x 16" / 40 x 40cm CASE QTY.: 5  
PART NO.: **MN60U** SIZE: 32" x 24" / 80 x 60cm CASE QTY.: 1

- Premium microfiber cloth for streak-free glass and window cleaning
- Four scrub zones for extra cleaning power
- Wash Cycles: 500

RubOut

The Pill Glass Cleaner



MicroWipe™

Ninja MicroWipe™

EasyGlide Glass Cleaner



## Buckets

### Bucket with Sieve

PART NO.: **QB120** CAPACITY: 4.5 gal./18L CASE QTY.: 10

- Excellent for window cleaning
- Easy to handle and lightweight
- Plastic sieve for washer and squeegee
- Holds up to 4.5 gallons and 14" washer

### Pro Bucket

PART NO.: **QB220** CAPACITY: 6 gal./28L CASE QTY.: 5

- Heavy-duty bucket with ergonomic handle
- Holds over six gallons of liquid and 18" T-bar
- Includes measuring units, large footprint for increased stability, and rounded pour spouts on two corners for easy emptying

### Pro Bucket Lid

PART NO.: **QB080** CASE QTY.: 5

- Sturdy snap-on lid for Pro Bucket
- Notched tabs lock handle into upright position when lid is in place
- Inner seal provides splash and leak protection.
- Removes easily using tabs on each corner

### Bucket Sieve

PART NO.: **QB060** CASE QTY.: 5

- Bucket sieve for wringing out washers
- Features a chemical-resistant coating
- Can wring out up to an 18" washer



Bucket with Sieve



Pro Bucket



Bucket Lid



Sieve

## Tool Holders

### Leather Holster

PART NO.: **HT000** CASE QTY.: 5

- Leather tool holder with two compartments
- Holds squeegees and washers
- Made of top grain leather and attaches to any belt

### The Belt

PART NO.: **UB000** CASE QTY.: 5

- For attaching the Bucket On A Belt and other tools
- Two loops hold additional tools
- Easy-to-use, side-release buckle
- Made with 2" heavy-duty nylon webbing

### ErgoTec® Belt

PART NO.: **BSTBT** SIZE: 32"-50" / 80-130cm CASE QTY.: 1

- Sturdy padded belt for carrying tool pouches
- Four clips, quick-release closure

### Bucket On A Belt

PART NO.: **BB010** STYLE: ErgoTec Ninja CASE QTY.: 5  
PART NO.: **BB020** STYLE: Classic CASE QTY.: 5

- Holder for squeegees, washer, scraper, and cleaning liquid
- Holds all important tools at your side, reducing the need to climb up and down ladders
- Available in ErgoTec® and classic versions
- ErgoTec® version is for right- or left-handed use
- Sturdy quick-release strap for easy removal from belt

Leather Holster

The Belt

ErgoTec® Ninja Bucket on a Belt



Classic Bucket on a Belt



ErgoTec Belt



ErgoTec Pouch



ErgoTec Double Holster

### ErgoTec® Pouch

PART NO.: **BSP0U** SIZE: 12" x 14.5" / 30 x 37cm CASE QTY.: 1

- Contains three waterproof compartments for storing dry and damp cloths separately
- Front pocket features tool loop and hook and loop closure

### ErgoTec® Double Holster

PART NO.: **BSDHR** SIZE: 3" x 5" / 8 x 13cm CASE QTY.: 1

- Made with strong black leather with two compartments for squeegees or other tools
- Attaches to belt using metal snaps

# Indoor Glass Cleaning

By applying the same high standards of quality and innovation to indoor glass cleaning tools as outdoor window tools, Unger has become recognized glass experts, inside and out!

No matter the job, Unger has a line of indoor glass cleaning tools designed to maximize efficiency without sacrificing performance.



Stingray  
Cleaning Kits

28

SpeedClean Kits

30

Glass Cleaning  
Accessories

31

Spare Parts

66

# Stingray Cleaning Kits



## Clean Windows

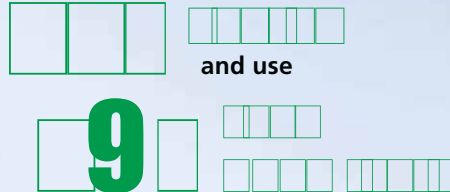

than traditional spray and cloth cleaning<sup>1</sup>

Cleaning professionals face two key challenges: efficiency and safety. Current tools lead to time-consuming issues, like re-arranging furniture and reaching high or unusually positioned windows. The battery powered Unger Stingray increases productivity and safety by eliminating time spent moving furniture or climbing ladders.

<sup>1</sup>Source: "Interior Glass Cleaning," 16.07.15, Sabine R. Mück, Hygiene Consult Mück

## Product Features

- Superior Cleaning Power**  
 Lint free, easy glide microfiber collects dust, fingerprints, grease and other light dirt
- Minimized Airborne Chemicals**  
 Pad design incorporates protective cut-out for precise liquid application reducing the chance of inhaling chemicals
- Cleans and Protects**  
 Scotchgard™ Protection makes glass easier to clean over time
- Fill and Go**  
 Refilling is simple and quick, thus increasing productivity
- Push Button Simplicity**  
 Effortlessly apply glass cleaner at the push of a button at any height
- Strong and Flexible**  
 Robust, articulating joint makes cleaning hard to reach areas easier



### Stingray Indoor Cleaning Kit - Deluxe 10'

PART NO.: **SRKT8** CASE QTY: 1

- Kit Includes:
- Stingray Handheld
- SREPL Extension Pole - Long 3.5'/1.1m (2)
- SREPS Extension Pole - Short 1.5'/0.5m (1)
- SRPD1 Glass Cleaning Pad (2)
- SRPD2 Deep Cleaning Pad (1)
- SRL02 Glass Cleaner (6)
- SRBAG Stingray Carrying Bag
- Includes 2-AA Batteries

### Stingray Indoor Cleaning Kit - 10'

PART NO.: **SRKT6** CASE QTY: 1

- Kit Includes:
- Stingray Handheld
- SREPL Extension Pole - Long 3.5'/1.1m (2)
- SREPS Extension Pole - Short 1.5'/0.5m (1)
- SRPD1 Glass Cleaning Pad (2)
- SRL02 Glass Cleaner (3)
- Includes 2-AA Batteries

### Stingray Indoor Cleaning Kit - 5'

PART NO.: **SRKT7** CASE QTY: 1

- Kit Includes:
- Stingray Handheld
- SREPL Extension Pole - Long 3.5'/1.1m (1)
- SRPD1 Glass Cleaning Pad (2)
- SRL02 Glass Cleaner (3)
- Includes 2-AA Batteries

### Stingray Indoor Cleaning Kit - 3'

PART NO.: **SRKT5** CASE QTY: 1

- Kit Includes:
- Stingray Handheld
- SREPS Extension Pole - Short 1.5'/0.5m (1)
- SRPD1 Glass Cleaning Pad (2)
- SRL02 Glass Cleaner (3)
- Includes 2-AA Batteries



### Stingray Indoor Cleaning Kit - Handheld

PART NO.: **SRKT4** CASE QTY: 1

- Kit Includes:
- Stingray Handheld
- SRPD1 Glass Cleaning Pad (2)
- SRL02 Glass Cleaner (3)
- Includes 2-AA Batteries

## Stingray Accessories



### Stingray Glass Cleaning Pad

PART NO.: **SRPD1** CASE QTY: 5

- Triangle shape for perfect reach into corners
- Elastic bands for secure fit and easy assembly
- Removes dust, fingerprints, grease, and other light dirt
- Wash Cycles: 200

### Stingray Deep Cleaning Pad

PART NO.: **SRPD2** CASE QTY: 5

- Triangle shape for perfect reach into corners
- Elastic bands for secure fit and easy assembly
- Long fibers for removing heavy dirt and grime
- Wash Cycles: 300

### Stingray Professional Glass Cleaner

PART NO.: **SRL02** CASE QTY: 24

- Streak-free cleaning and fast drying
- Scotchgard™ Protection makes glass easier to clean over time
- 5 fl. oz. /150 mL

### Stingray Extension Pole – Long

PART NO.: **SREPL** CASE QTY: 1

- Length: 3.5 ft/1.1m
- Triangular shape for better grip
- Light, rigid aluminum
- Easy-click connection and activation button

### Stingray Extension Pole – Short

PART NO.: **SREPS** CASE QTY: 1

- Length: 1.5 ft/0.5m
- Triangular shape for better grip
- Light, rigid aluminum
- Easy-click connection and activation button

### Stingray Carrying Bag

PART NO.: **SRBAG** CASE QTY: 1

- Lightweight, nylon bag with full length zipper allows bag to open flat
- Holds any Unger Stingray Kit for easy access
- Multiple fasteners and pockets for additional tools and literature

# SpeedClean™ Kits

## SpeedClean™



### SpeedClean™ Window Kit

PART NO.: **CK054** CASE QTY.: 1

**- Kit Contents:**

- SOABG Sprayer On A Belt
- PHH20 Aluminum Pad Holder
- PHD20 Handheld Aluminum Pad Holder

- PHW20 Microfiber Washing Pad (3)
- PHL20 Microfiber Cleaning Pad (3)
- AFAET HiFlo™ Euro Thread Adapter
- ED180 OptiLoc™ 3-Section Telescopic Pole - 6'



### SpeedClean™ Starter Kit

PART NO.: **WNK04** CASE QTY.: 4

**- Kit Contents:**

- PHH20 Aluminum Pad Holder
- PHW20 Microfiber Washing Pad
- PHL20 Microfiber Cleaning Pad
- AFAET HiFlo™ Thread Adapter
- EZ120 OptiLoc™ 2-Section Telescopic Pole - 4'

*The SpeedClean™ Starter Kit comes as a self-packaged piece with all contents.*



Attach two tools with the Y-Adapter.



### Extend Your Reach!

All SpeedClean kits attach to Unger's line of Telescopic Poles (see page 38). For additional high-access window cleaning tools, see page 15.

## Glass Cleaning Accessories



### Microfiber Washing Pad

PART NO.: **PHW20** SIZE: 8"/20cm CASE QTY.: 5

- Long fibers for removing heavy dirt and grime
- Best cleaning with minimal drag
- Use with pad holder PHH20 or PHD20
- Wash Cycles: 500

### Microfiber Cleaning Pad

PART NO.: **PHL20** SIZE: 8"/20cm CASE QTY.: 5

- Cleans glass with less drag
- Removes dust, fingerprints, grease, and other light dirt from glass
- Use with pad holder PHH20 or PHD20.
- Wash Cycles: 100

### Scrub Pad

PART NO.: **OPS20** SIZE: 8"/20cm CASE QTY.: 10

- Special scrub pad for removing tough soils
- Optimal for outdoor cleaning
- Use with pad holder PHH20 or PHD20



### Aluminum Pad Holder

PART NO.: **PHH20** SIZE: 8"/20cm CASE QTY.: 5

- Pad holder with swivel head easily glides across windows
- Attach to Unger pole with thread adapter AFAET
- Full coverage hook and loop fastener backing for strong hold of pads



### Handheld Aluminum Pad Holder

PART NO.: **PHD20** SIZE: 8"/20cm CASE QTY.: 5

- Perfect hand control and power distribution while cleaning glass with less drag
- Full coverage hook and loop fastener backing for strong hold of pads



### HiFlo™ Euro Thread Adapter

PART NO.: **AFAET** CASE QTY.: 5

- Adapter connects aluminum poles to pad holder and other tools with euro thread



### Sprayer On A Belt Patented

PART NO.: **SOABG** CAPACITY: 33oz/1L CASE QTY.: 5

- Sprayer hooks onto belt, providing optimal weight support
- Flexible hose extends 3' for upside-down spraying
- Includes SmartColor™ Decal Kit to customize for designated areas

## Indoor Cleaning Kit Advantages

	STINGRAY	SPEEDCLEAN™	STARTER KIT
<b>Everyday Cleaning</b> Easy to use with little training	●	●	●
<b>Clean Hard to Reach Areas</b> Low-profile, easy to maneuver cleaning heads	●	●	●
<b>Power of Microfiber</b> Tough on dirt and easy on glass without the waste of paper products	●	●	●
<b>3M Glass Cleaner &amp; Protector</b> Keeps glass cleaner, longer with Scotchgard protection	●		
<b>Modular Quick-Click Poles</b> Ergonomic poles designed for control and minimal weight	●		
<b>Minimize Airborne Chemicals</b> Enclosed nozzle keeps cleaning liquid on the glass and out of the air	●		
<b>Complete Cleaning Kit</b> Everything needed for a full indoor glass cleaning routine	●	●	
<b>nLite Compatible</b> Clean up to 65' by using with the Unger nLite poles		●	●



# Dusting and High Access Cleaning

Unger has every tool you need for dusting and high access jobs. Unger's diverse selection of dusters guarantees the perfect tool for every job. Avoid using ladders with our high access poles and variety of bulb changers. Unger's professional-grade high access tools keeps you on the ground allowing you to easily reach trouble areas and to keep ceiling fixtures dust-free.

Dusting Tools

34

Brushes  
& Cleaning Kits

36

Bulb Changing  
Tools &  
Tool Adapters

37

Telescopic  
Poles

38

Spare Parts



# Dusting Tools



## DUSTING

By attaching an appropriate Unger adapter, you can expand the cleaning performance of a nLite pole. Clean windows and glass "Inside and Out" all year round!

nLite Poles  
Extend Up to 55'

Aluminum  
Telescopic Pole

FRALC HiRo nLite Locking Cone Adapter

FTHR MultiLink Thread Adapter  
(included with nLite pole)

FLCA HiRo MultiLink  
Cone Adapter  
(See page 14 for details)

## BULB CHANGING

Remove the ErgoTec Locking cone in order to attach all bulb changing tools.

Flood Sucker  
Bulb Changer

Sticky Fingers  
Bulb Changer

The Bebbe

### StarDuster® ProFlex

PART NO.: PXD7G SIZE: 30" / 75cm CASE QTY: 10

### StarDuster® ProFlat

PART NO.: PFD7G SIZE: 30" / 75cm CASE QTY: 10

- ProFlex (PXD7G): Bends and retains shape to clean hard-to-reach areas
- ProFlat (PFD7G) retains its shape to slide between tight spaces
- Great for cleaning overhead, underneath furniture, appliances, and around corners
- Microfiber sleeve is removable and machine washable
- Comes with three electrostatic disposable sleeves (wash cycles: 300)

### StarDuster® ProFlex/ProFlat Sleeves

PART NO.: PS50W CONTENTS: 50 CASE QTY: 1

PART NO.: PM05W CONTENTS: 5 CASE QTY: 1

- PS50W: Disposable, electrostatic replacement sleeves for ProFlex (PXD7G) and ProFlat (PFD7G) dusters
- PM05W microfiber replacement sleeves are machine washable (wash cycles: 300)

### StarDuster® Pro Duster

PART NO.: LWDUR SIZE: 30" - 60" / 70 - 150cm CASE QTY: 10

- Telescopic lambswool duster with bendable head and sleeve
- Ideal for dusting in high places
- Disposable duster sleeve attracts and holds dust, keeping it away from workers and fixtures below

### StarDuster® Lambswool

PART NO.: LWDUO CASE QTY: 6

- Perfect for dusting shelves and other surfaces
- Superior cleaning and dust removal
- Duster attaches to any Unger cone or standard ACME thread
- Also use with Pro Duster Replacement Sleeves (DS50Y) or microfiber (MMSLG)

### StarDuster® Pro Duster/Lambswool Replacement Sleeves

PART NO.: DS10Y CONTENTS: 10 Pack Sleeve CASE QTY: 1

PART NO.: DS50Y CONTENTS: 50 Pack Sleeve CASE QTY: 1

- Disposable duster sleeve attracts and holds dust, keeping it away from workers and fixtures below

### Pro Micro Sleeve

PART NO.: MMSLG SIZE: 6" x 14" / 15 x 36cm CASE QTY: 5

- Microfiber sleeve fits over lambswool and poly duster heads, preserving the heads and increasing efficiency
- Attracts and traps more dust than ordinary duster
- Wash Cycles: 300

StarDuster®  
ProFlex



StarDuster®  
Pro Flat



Micro Mitt  
Heavy Duty

### Micro Mitt Heavy Duty

PART NO.: MMIRG CASE QTY: 5

- Thick, soft microfiber strands allow increased surface contact for incredible absorbency and dirt pickup
- Premium-grade low pile microfiber on reverse side is ideal for dusting and polishing
- Wash Cycles: 300

StarDuster®  
Pro Duster



StarDuster®  
Lambswool

Pro Micro  
Sleeve

StarDuster®  
Pro Ceiling  
Fan Duster



### StarDuster® Pro Ceiling Fan Duster

Patented  
PART NO.: CEDUG CASE QTY: 5

- Thick, soft microfiber strands cleans all shapes and sizes of ceiling fan blades, and vents
- Microfiber sleeve is removable and machine washable
- Wash Cycles: 300

### StarDuster® Pro Ceiling Fan Duster Replacement Sleeve

PART NO.: CE05G CONTENTS: 5 CASE QTY: 1

## Tool Connections



### Lock On

Any tool with a hole in the handle and "LOCK" inscribed on it locks onto the ErgoTec® Locking Cone preventing the tool from twisting or pulling off the pole during work.



### Press On

Special grooves on the cone ensure a secure fit for the tools.



### Screw On

These tools screw onto the ACME thread of an Unger cone.



### Snap On

These tools snap directly onto Unger telescopic poles.

# Brushes & Cleaning Kits



## StarDuster® Pipe Brush

PART NO.: PIPEO CASE QTY.: 5

- Bendable 11" curved brush for cleaning pipes and other round surfaces
- Made with heavy-duty wire and polypropylene bristles



## StarDuster® Wall Brush

PART NO.: WALBO CASE QTY.: 5

- Oval shape for ceiling fans, walls, and ceilings
- Made of heavy-duty galvanized wire and 49% horsehair bristles
- Ideal for dusting rough surfaces, and for removing cobwebs and dust from flat objects



## CobWeb Duster Brush *Patented*

PART NO.: COBWO CASE QTY.: 6

- Split-tipped soft poly fibers allow for effective dusting without scratching
- Great for dusting ceilings, moldings, and corners inside or outdoors
- Electrostatic energy attracts and holds dust, dirt, and cobwebs



## Connect & Clean Indoors with the nLite® Pole System

See Page 34 for Details

## High Access Dusting Starter Kit

PART NO.: CK055 CASE QTY.: 1

- Convenient multi-surface dusting tool kit
- Kit Contents:
  - PIPEO StarDuster® Pipe Brush
  - WALBO StarDuster® Wall Brush
  - CEDUG StarDuster® Pro Ceiling Fan Duster
  - HFNLC HiFlo nLite Locking Cone Adapter
  - PXD7G StarDuster® ProFlex
  - PSS5W StarDuster® ProFlex Sleeves (50)



## Bulb Changing Tools



## Flood Sucker Bulb Changer

PART NO.: FS000 CASE QTY.: 5

- Easily change floodlights and other flat lightbulbs safely from the ground
- Features suction cups that attach to bulb
- Fully insulated
- Snaps onto telescopic poles for changing bulbs in high-access areas



## Sticky Fingers Bulb Changer

PART NO.: BS010 CASE QTY.: 5

- Easily change lightbulbs safely from the ground
- Rubber-coated spring steel fingers for quality turning power
- Adjusts to fit various-shaped CFL bulbs
- Fully insulated
- Snaps onto telescopic poles for changing bulbs in high-access areas



## The Bebe®

PART NO.: BEBEO CASE QTY.: 5

- Safely remove broken lightbulb base from socket
- Complete with plastic tray for catching broken bulb pieces
- Fully insulated
- Snaps onto telescopic poles for changing bulbs in high-access areas

## Tool Adapters



## ErgoTec® Locking Cone *Patented*

PART NO.: NCANO CASE QTY.: 5

- Securely locks select Unger tools onto pole
- Fast tool change with quick-release button
- Other tools attach by pressing on, snap on, or screw on



## HiFlo nLite Locking Cone Adapter

PART NO.: HFNLC CASE QTY.: 1

- Plastic adapter with ErgoTec® Locking Cone for attaching classic tools to nLite poles
- Inserts into nLite master pole and secures with yellow clamp
- Quick and easy tool change via release button



## Threaded Wood Cone Adapter

PART NO.: TWA00 CASE QTY.: 5

- Wood cone adapter for attaching tools
- Features an internal ACME thread
- Pressure fitted



## Cranked Joint Angle Adapter

PART NO.: CJA00 THREAD: Zinc CASE QTY.: 5

PART NO.: CJN00 THREAD: Plastic CASE QTY.: 5

- Adjust tools to clean at any angle up to 300°
- Squeeges, washers, etc. quickly attach to adapter
- Available in strong zinc or plastic

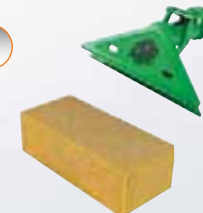

## Fixi-Clamp

PART NO.: FIX10 ITEM: Fixi-Clamp CASE QTY.: 5

PART NO.: SP010 ITEM: Sponge CASE QTY.: 10

- Adjustable plastic clamp firmly holds tools like brushes, sponges, and cloths
- Open cellulose foam sponge is perfect for general cleaning and can be used with Fixi-Clamp

## Soot Master Sponge

PART NO.: SP060 SIZE: 2" x 3" x 6" CASE QTY.: 6

- Perfect for cleanup after fire or smoke damage
- Dry sponge absorbs dust and soot particles
- Can be cut, if smaller size is required.
- Rinsable rubber material

# Telescopic Poles

High-access cleaning simplified. Wherever there is a need for extended reach, choose an Unger telescopic pole.

All of Unger's poles have ergonomic handles for worker comfort. All fit a full range of cleaning tools – washers, squeegees, dusters, and brushes.

No matter what the job, using an Unger pole allows performance and safety to be top priorities.

## Henry's Handi Handle

- Ergonomic, one section handle with ErgoTec® Locking Cone

PART NO.: **HH240** LENGTH: 2'/60cm SECTIONS: 1 PACK UNIT: 5

## UniTec™

- Telescopic pole in two sections  
- Features an interior lock that secures with a half turn in either direction

PART NO.: **OS210** LENGTH: 6.5'/2m SECTIONS: 2 PACK UNIT: Any 10  
 PART NO.: **OS250** LENGTH: 10'/3m SECTIONS: 2 PACK UNIT: Any 10  
 PART NO.: **OS260** LENGTH: 13'/4m SECTIONS: 2 PACK UNIT: Any 10

## OptiLoc™ 2-Section Poles

- Work safely from the ground with sturdy 2-section telescopic extension poles  
- Constructed of anodized, extruded drawn aluminum with 3-1/2" nylon locking collars and ErgoTec® Locking Cone  
- Handle grip is ergonomically designed for comfort  
- Use with Unger High Access and Window Cleaning tools

PART NO.: **EZ120** LENGTH: 4'/1.25m SECTIONS: 2 PACK UNIT: Any 10  
 PART NO.: **EZ250** LENGTH: 8'/2.50m SECTIONS: 2 PACK UNIT: Any 10  
 PART NO.: **EZ300** LENGTH: 10'/3m SECTIONS: 2 PACK UNIT: Any 10  
 PART NO.: **EZ400** LENGTH: 13'/4m SECTIONS: 2 PACK UNIT: Any 10  
 PART NO.: **EZ500\*** LENGTH: 16'/5m SECTIONS: 2 PACK UNIT: Any 10  
 PART NO.: **EZ600\*** LENGTH: 20'/6m SECTIONS: 2 PACK UNIT: Any 10

## OptiLoc™ 3-Section Poles

- Work safely from the ground with sturdy 3-section telescopic extension poles

PART NO.: **ED180** LENGTH: 6'/1.85m SECTIONS: 3 PACK UNIT: Any 10  
 PART NO.: **ED370** LENGTH: 12'/3.75m SECTIONS: 3 PACK UNIT: Any 10  
 PART NO.: **ED450** LENGTH: 14'/4.5m SECTIONS: 3 PACK UNIT: Any 10  
 PART NO.: **ED550** LENGTH: 18'/5.5m SECTIONS: 3 PACK UNIT: Any 10  
 PART NO.: **ED600** LENGTH: 20'/6m SECTIONS: 3 PACK UNIT: Any 10  
 PART NO.: **ED750\*** LENGTH: 24'/7.5m SECTIONS: 3 PACK UNIT: Any 10  
 PART NO.: **ED900\*** LENGTH: 30'/9m SECTIONS: 3 PACK UNIT: Any 10

## Tool Connections



### Lock On

Any tool with a hole in the handle and "LOCK" inscribed on it locks onto the ErgoTec® Locking Cone preventing the tool from twisting or pulling off the pole during work.



### Press On

Special grooves on the cone ensure a secure fit for the tools.



### Screw On

These tools screw onto the ACME thread of an Unger cone.



### Snap On

These tools snap directly onto Unger telescopic poles.

## Henry's Handi Handle

• Allows for easier access to hard-to-reach places.

## UniTec™

• 2-section telescopic pole, available in three sizes.  
• Interior lock, 1/2 turn in either direction.

## OptiLoc™

• 2- or 3-section telescopic pole available in 13 sizes.



## TelePlus Pole System

TelePlus is a flexible, modular system. The poles are available in 2- or 3-section starter units, with 6-foot extensions. The TelePlus system enables you to easily reach heights from 12 to 30 feet and allows you to only carry the sections you need.

The poles, made of drawn anodized aluminum, are light and can be handled easily and safely even when assembled to provide a maximum reach.

## Customize Your System:

*Plus 3 extends the basic 2-section pole*

*Plus 4 extends the basic 3-section or Plus 3*

*Plus 5 extends the basic 4-section or Plus 4*

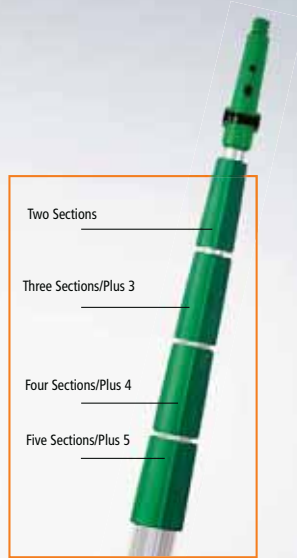
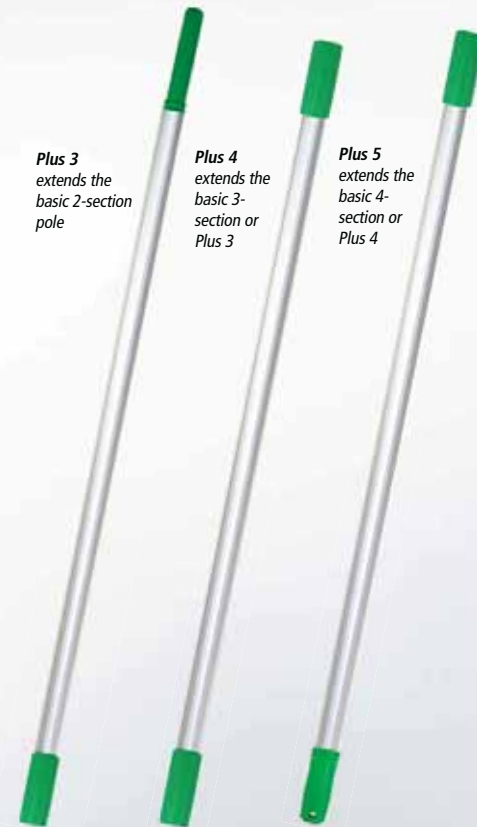

## TelePlus™ 6'/1.85m System

- Modular Telescopic pole with the ErgoTec® Locking Cone

PART NO.: **TZ370** LENGTH: 12'/3.75m SECTIONS: 2 PACK UNIT: Any 10  
 PART NO.: **TD550** LENGTH: 18'/5.5m SECTIONS: 3 PACK UNIT: Any 10  
 PART NO.: **TV750** LENGTH: 24'/7.5m SECTIONS: 4 PACK UNIT: Any 10  
 PART NO.: **TF900** LENGTH: 30'/9m SECTIONS: 5 PACK UNIT: Any 10

## Plus 3

- 6-foot extensions for 2-section base TelePlus™ modular pole system

PART NO.: **T3180** LENGTH: 6'/1.85m SECTIONS: 1 PACK UNIT: Any 10

## Plus 4

- 6-foot extensions for 3-section base TelePlus™ modular pole system

PART NO.: **T4180** LENGTH: 6'/1.85m SECTIONS: 1 PACK UNIT: Any 10

## Plus 5

- 6-foot extensions for 4-section base TelePlus™ modular pole system

PART NO.: **T5180** LENGTH: 6'/1.85m SECTIONS: 1 PACK UNIT: Any 10

\*Item ships by truck only. \$1,200 orders are freight free for truck shipments within the 48 contiguous states. Minimum of 10 poles required. Use any combination of sizes to reach minimum.

# Surface and Floor Care

When cleaning a facility, Safety, Efficiency, and Cleanliness are top priorities. In developing cleaning systems, Unger has taken these priorities and created a line of cleaning systems and tools designed to maximize each.

From the custodian designed RestroomRx system, to the massive pushing capacity of AquaDozer Max, the many small, unique elements that only Unger includes are what set Unger apart in the cleaning industry.

Dual Bucket System & SmartColor™ Cleaning **42**

Restroom Cart Systems **44**

MicroWipe™ Microfiber Cloths **47**

Surface Cleaning **48**

Tool Holders & Buckets **50**

Floor Care & Mopping **54**

Floor Scrapers & Blades **56**

Pro Aluminum Handles **57**

Floor Squeegees **58**

Spare Parts **67**

# Dual Bucket System

## Increase Productivity & Improve Hygiene

The Unger RestroomR<sub>x</sub> Bucket System sets the standard for cleaning efficiency and hygiene.

Its many distinctive ergonomic design features enhance worker productivity, reduce injuries, and increased cleaning performance.

- Separate Cleaning Solution from Soiled Rinse Water
- Prevent Cross-Contamination
- Save on Water and Chemicals
- Up to 63% Lighter when Full
- Mounts on all Standard Cleaning Carts
- Casters Removable for Additional Stability
- Two 4-Gallon Capacity Compartments
- Additional Cleaning Tools can be Stored on Front Handle or in Optional Side Bucket

Immerse mop in front compartment for fresh cleaning solution

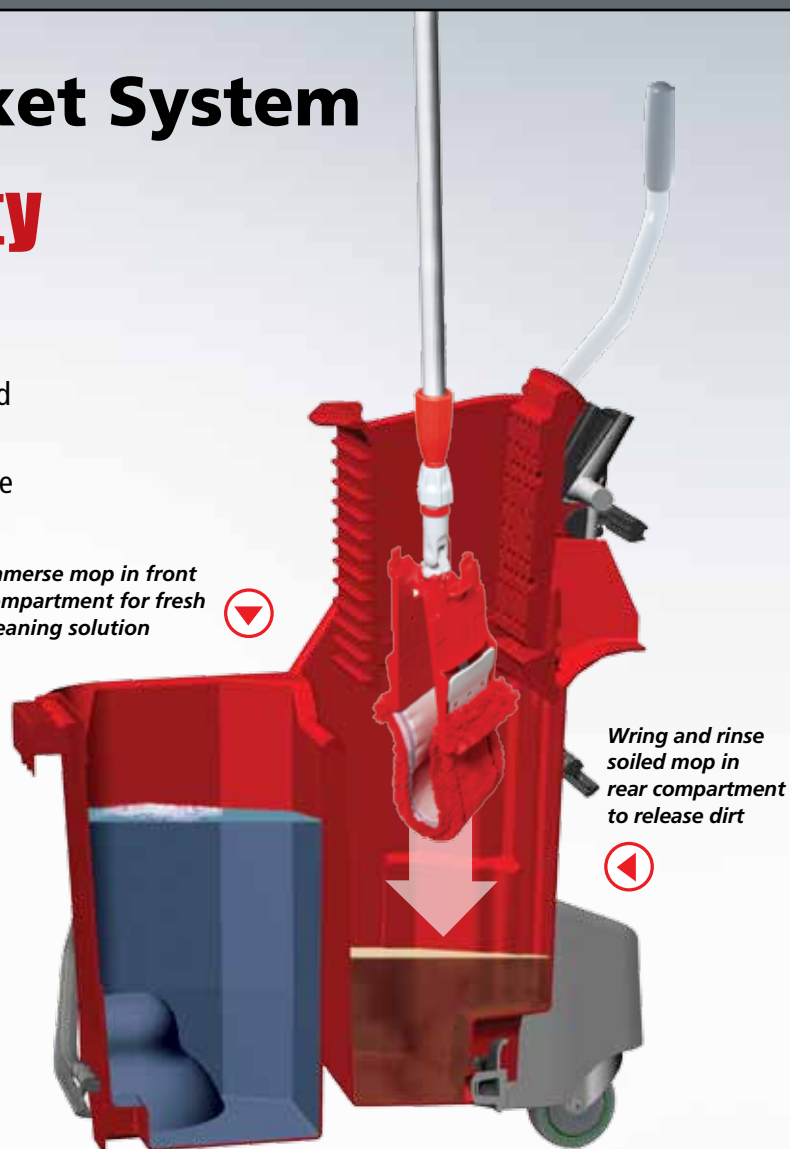

Wring and rinse soiled mop in rear compartment to release dirt

# SmartColor™ Cleaning System

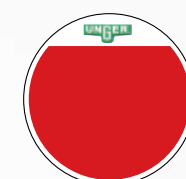
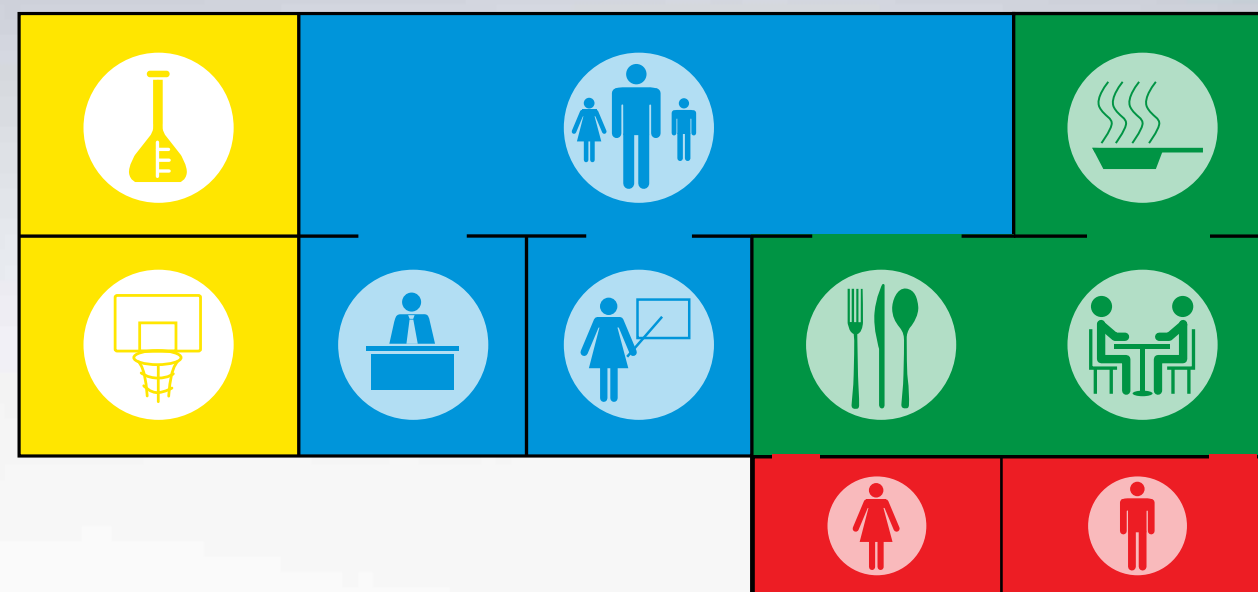

Restrooms  
High Bacteria Areas

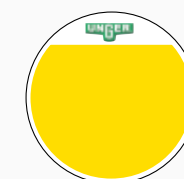

Speciality Areas  
Laboratories  
Gymnasiums



Break Rooms  
Kitchens  
Food Service Areas

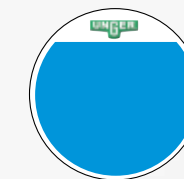

General Areas  
Low-Risk Bacteria Areas  
Offices/Lobbies/Classrooms

### The Advantages of Color-Coding:

- Improves Training and Communication
- Prevents Cross-Contamination
- Enhances Building Safety
- Deters Chemical Misuse
- Simplifies Supply Management
- Elevates Employee Performance

Every facility is unique, which is why the Unger SmartColor is the first visual coding system designed to adapt to the specific, and changing, needs of your business. As your building's footprint grows or personnel needs fluctuate, SmartColor will keep your business ahead of all its cleaning demands.

SmartColor achieves its distinct color-coding through interchangeable features and durable metallic decals. This gives you the flexibility to easily re-task tools for different areas or functions as required.

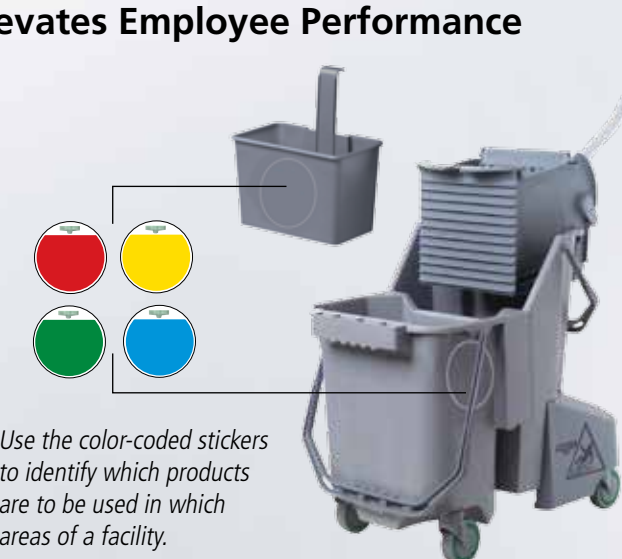

Use the color-coded stickers to identify which products are to be used in which areas of a facility.

## Dual Bucket System vs. Single Bucket

Black light experiment reveals the advantages of using the Unger Dual Bucket System. Dirt is captured and removed by the microfiber mop and wrung out in the back of the bucket. The mop is then dipped into the unsoiled front compartment containing floor cleaning solution and mopping continues. In a single bucket, the mop is dipped into the soiled water then wrung out returning soiled water to the floor surface.

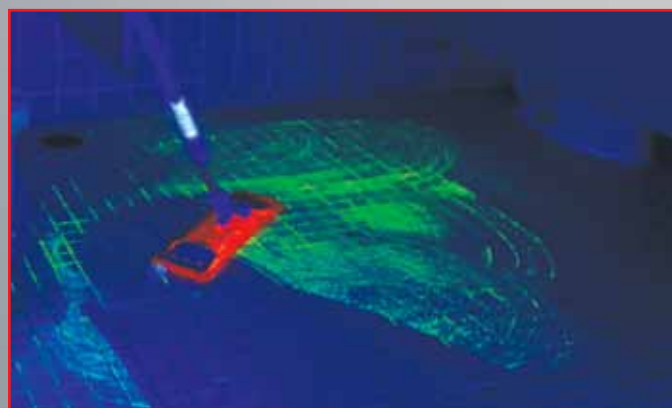

After cleaning with Unger's Microfiber Mop and Dual Bucket, all soils are captured and removed from the floor.

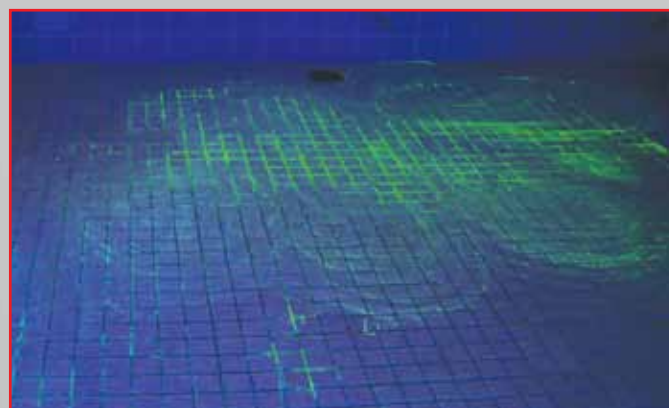

After cleaning with a traditional single bucket, remaining soil appears neon yellow.

# Restroom Cart Systems

## RESTROOMRx™ A HIGHER LEVEL OF CLEAN

The best way to clean is with an efficient system, and the Unger RestroomRx is the first janitorial cart developed as a completely coordinated system by cleaning professionals.

Every detail is designed for ergonomics and safety. Tools stay organized and securely fastened in place while moving from job to job.

The Unger RestroomRx streamlined cart systems will enable your custodians to work faster and more productively than ever.

### ► EASY TO MANEUVER

The handrail allows you to maneuver the cart in and out of restroom entrances quicker and easier.

### ► STAY ORGANIZED

Every tool in the system has a designated position on the cart. Tools are always where they need to be, and always clipped on securely.

### ► LARGE STORAGE

With an expanded storage module, you'll substantially limit trips to the supply closet.

### ► SMART DESIGN

The narrow tool tower design allows all tools to remain within the boundaries of the cart. The base of the cart also acts as a drip tray catching excess liquid, so nothing ever drips on restroom or hallway floors.



**70%** Savings on  
Chemical and  
Water Usage!

## SAFETY

The Ergo Rail eliminates poor posture. No matter which side of the cart you're on, it can be pushed and pulled with ease.

The handrail allows you to maneuver the cart in and out of restroom entrances quicker and easier.

Patented clip system ensures all tools have an identified position on the cart. Tools are securely in place while you are moving down the hall. No bending or reaching to get tools out/off of the cart.

## EFFICIENCY

The Storage Module eliminates restroom complaints. The effort it takes to return to a supply closet to restock supplies can waste more than just time.

With an expanded storage module, you'll substantially limit trips to the supply closet. Even eliminating one trip increases productivity.

The patent pending Narrow Tool Tower design allows all tools to remain within the boundaries of the cart. Since no tools hang over the outside edge of the cart, getting through even tight doorways is easy.

## CLEANLINESS

From the Dual Bucket to the Telescopic Dustpan, the tools that comprise the system were developed to deliver optimal productivity and cleaning results.

A patent pending Drip Tray keeps dripping from tools off the floor, and delivers ultimate bucket stability, even when going over curbs or thresholds.



### RestroomRx Cleaning Specialist System Complete - 32 Qt.

PART NO.: RRSPL CAPACITY: 32 Qt./30L CASE QTY: 1

#### - Kit Contents:

RRCRT	Cleaning Cart <i>(includes vinyl trash bag, supply module, all tool clips and holders)</i>	WH180	Easy Adapter Hose
		LWDUR	StarDuster® Pro Duster with Sleeve
COMBR	Dual-Compartment Mop Bucket - 32 Qt.	EDTBR	Ergo Dustpan Telescopic
		NN40R	NiftyNabber® 18"
SM40R	EZ Mop Holder	NCANR	ErgoTec Locking Cone - Red (2)
EP18R	Ergo TelePole Compact - 6'	CB20G	SmartColor™ Swivel Corner Brush
MM40R	SmartColor™ Micro Mop 15.0 - Red	SB20G	SmartColor™ Swivel Brush
BBWHR	Ergo Toilet Bowl Brush <i>(includes 18369, black base for holder)</i>		

### RestroomRx Cleaning Specialist System - Starter

PART NO.: RRSPS CAPACITY: 16 Qt./15L CASE QTY: 1

#### - Kit Contents:

RRCRT	Cleaning Cart (includes vinyl trash bag, all tool clips and holders)
COMSR	Dual-Compartment Mop Bucket - 16 Qt.
SM40R	EZ Mop Holder
MM40R	SmartColor™ Micro Mop 15.0 - Red
EP18R	Ergo TelePole Compact - 6'

### RestroomRx Cleaning Specialist System Complete - 16 Qt.

PART NO.: RRSPC CAPACITY: 16 Qt./15L CASE QTY: 1

#### - Kit Contents:

RRCRT	Cleaning Cart <i>(includes vinyl trash bag, supply module, all tool clips and holders)</i>	WH180	Easy Adapter Hose
		LWDUR	StarDuster® Pro Duster with Sleeve
COMSR	Dual-Compartment Mop Bucket - 16 Qt.	EDTBR	Ergo Dustpan Telescopic
		NN40R	NiftyNabber® 18"
SM40R	EZ Mop Holder	NCANR	ErgoTec Locking Cone - Red (2)
EP18R	Ergo TelePole Compact - 6'	CB20G	SmartColor™ Swivel Corner Brush
MM40R	SmartColor™ Micro Mop 15.0 - Red	SB20G	SmartColor™ Swivel Brush
BBWHR	Ergo Toilet Bowl Brush <i>(includes 18369, black base for holder)</i>		

### RestroomRx Cleaning Double Supply Cart

PART NO.: RRBSC CAPACITY: 16 Qt./15L CASE QTY: 1

#### - Kit Contents:

Tool clips and holders  
Vinyl Supply Module



### RestroomRx Cleaning Cart

PART NO.: RRCRT CASE QTY: 1

- Kit Contents:  
Tool clips and holders  
Vinyl Trash Bag



# Restroom Cleaning Kits



## Restroom Master Cleaning Kit

PART NO.: MKITR CASE QTY: 1

CONTENTS: Master Restroom Cleaning Kit (Includes Daily &amp; Project Tools)

- Kit Contents:

- COMBR Dual Bucket - 32 Qt.
- ES35R ErgoTec® Squeegee - 14"
- EP24R Ergo TelePole - 8'
- HH13R Ergo Pole - 4'
- LWDUR StarDuster® Pro Duster with 1 Sleeve
- DS10Y StarDuster® Pro Replacement Sleeves (10)
- WH180 Easy Adapter Hose
- MF40R SmartColor™ MicroWipe™ Red (10)
- MF40Y SmartColor™ MicroWipe™ Yellow/Red (10)
- MM40R SmartColor™ Micro Mop 15.0 (3)
- SM40R EZ Flat Mop Holder
- CB20G SmartColor™ Swivel Corner Brush
- SB20G SmartColor™ Swivel Brush
- EC45R SmartColor™ Washer - 18"
- BBWHR Ergo Toilet Bowl Brush - Complete
- EDPBR Ergo Dustpan with Broom
- UB000 Belt for Sprayer On A Belt
- SOABG Sprayer On A Belt
- NN40R NiftyNabber® 18"
- EW35R Ergo Wall Squeegee with ACME grip - 14"
- Training Materials



## Pro Restroom Cleaning Kit - Flat Mop

PART NO.: RRPRO CAPACITY: 32 Qt./30L CASE QTY: 1

- Kit Contents:

- COMBR Dual Bucket - 32 Qt.
- MS14G Knock Down Mop Handle
- BBWHR Ergo Toilet Bowl Brush - Complete
- SOABG Sprayer On A Belt
- MF40R SmartColor™ MicroWipe™ (5)
- MM40R Micro Mop 15.0
- SM40R EZ Flat Mop Holder
- Training material

## Restroom Floor Pack

PART NO.: SMFPR CAPACITY: 32 Qt./30L CASE QTY: 1

- Kit Contents:

- COMBR Dual Bucket - 32 Qt.
- MM40R SmartColor™ Micro Mop
- SM40R EZ Flat Mop Holder
- EP24R Ergo TelePole - 8'

## Restroom Complete Mop Pack

PART NO.: SMCRR CASE QTY: 1

- Kit Contents:

- MM40R SmartColor™ Micro Mop
- SM40R EZ Flat Mop Holder
- EP24R Ergo TelePole - 8'

## MicroWipe™ Grading System

	Specifications	Usage
<b>MicroWipe™ 4000 Heavy Duty</b>	<ul style="list-style-type: none"> <li>• Durability**: 4000</li> <li>• Wash Cycles: 1500</li> <li>• Scrub Factor**: 38 (Abrasiveness)</li> <li>• Absorbency*: 1700 ml or 5.2 oz</li> </ul>	<ul style="list-style-type: none"> <li>• <b>Highest quality superior-grade textile</b></li> <li>• Manufactured to withstand heavy-duty commercial washing cycles</li> <li>• Designed for facilities that clean in multiple shifts and seven days a week</li> <li>• Cleans industrial soil loads – oils, dry dust, embedded soils</li> <li>• Extended product life – lower long-term cost</li> <li>• Maximum absorbency</li> </ul>
<b>MicroWipe™ 2000 Medium Duty</b>	<ul style="list-style-type: none"> <li>• Durability**: 2000</li> <li>• Wash Cycles: 1000</li> <li>• Scrub Factor**: 36 (Abrasiveness)</li> <li>• Absorbency*: 1400 ml or 4.4 oz</li> </ul>	<ul style="list-style-type: none"> <li>• <b>Medium absorbency for general-purpose cleaning</b></li> <li>• Hand or normal wash / dry cycles</li> <li>• Designed for 5-day-a-week cleaning operations</li> <li>• Multipurpose surface applications</li> <li>• Cleans medium-duty soil loads</li> <li>• Average product life</li> </ul>
<b>MicroWipe™ 500 Light Duty</b>	<ul style="list-style-type: none"> <li>• Durability**: 500</li> <li>• Wash Cycles: 500</li> <li>• Scrub Factor**: 34 (Abrasiveness)</li> <li>• Absorbency*: 1100 ml or 3.3 oz</li> </ul>	<ul style="list-style-type: none"> <li>• <b>Good choice for daily dusting tasks</b></li> <li>• Least aggressive mechanical action</li> <li>• Shorter product life than medium- and heavy-duty</li> </ul>
<b>MicroWipe™ 200 UltraLite</b>	<ul style="list-style-type: none"> <li>• Durability**: 200</li> <li>• Wash Cycles: 200</li> <li>• Scrub Factor**: 39 (Abrasiveness)</li> <li>• Absorbency*: 1700 ml or 5.2 oz</li> </ul>	<ul style="list-style-type: none"> <li>• <b>Cleans light-duty soil loads</b></li> <li>• Dry / damp dusting tasks</li> <li>• Shortest product life cycle</li> <li>• Maximum absorbency</li> </ul>

\*Standard US Industry Test \*\*ASTM Tests

### MicroWipe 4000 Heavy Duty

PART NO.: MF40R COLOR: Red  
 PART NO.: MF40Y COLOR: Yellow/Red  
 PART NO.: MF40J COLOR: Yellow  
 PART NO.: MF400 COLOR: Green  
 PART NO.: MF40B COLOR: Blue  
 SIZE: 16" X 15"/40cm x 38cm  
 WASH CYCLES: 1500 CASE QTY: 10

### MicroWipe 2000 Medium Duty

PART NO.: MB40R COLOR: Red  
 PART NO.: MB40J COLOR: Yellow  
 PART NO.: MB400 COLOR: Green  
 PART NO.: MB40B COLOR: Blue  
 SIZE: 16" X 16"/40cm x 40cm  
 WASH CYCLES: 1000 CASE QTY: 10

### MicroWipe 500 Light Duty

PART NO.: MC40R COLOR: Red  
 PART NO.: MC40J COLOR: Yellow  
 PART NO.: MC400 COLOR: Green  
 PART NO.: MC40B COLOR: Blue  
 SIZE: 16" X 16"/40cm x 40cm  
 WASH CYCLES: 500 CASE QTY: 10

### MicroWipe 200 UltraLite

PART NO.: ME40R COLOR: Red  
 PART NO.: ME40J COLOR: Yellow  
 PART NO.: ME400 COLOR: Green  
 PART NO.: ME40B COLOR: Blue  
 SIZE: 16" X 16"/40cm x 40cm  
 WASH CYCLES: 200 CASE QTY: 10





# Restroom Surface Cleaning



## SmartColor™ Washer 15.0 Red

PART NO.: **EC45R** VERSION: Complete  
 SIZE: 18"/45cm CASE QTY: 10  
 PART NO.: **NS45R** VERSION: Sleeve  
 SIZE: 18"/45cm CASE QTY: 10

- Microfiber sleeve and T-bar for cleaning restroom mirrors, stalls, and walls
- Long-lasting, durable, 15.0 mm pile can penetrate small surfaces and remove dirt
- Absorbs up to six times its own weight of quick liquid pickup



## Ergo Wall Squeegee

PART NO.: **EW35R** SIZE: 14"/35cm CASE QTY: 10

- Dry or remove cleaning solutions in one quick step
- White, non-marking moss rubber is ideal for drying grout lines
- T-bar material made of acid-proof polypropylene
- Ergonomic handle can attach to Ergo TelePole (EP24R) or Ergo Pole (HH13R)



## ErgoTec® Squeegee

PART NO.: **ES35R** VERSION: Complete  
 SIZE: 14"/35cm CASE QTY: 10  
 PART NO.: **NE350** VERSION: Channel & Rubber  
 SIZE: 14"/35cm CASE QTY: 10

- Ergonomic squeegee for restroom mirrors and smooth surfaces
- Ergonomic, two-component handle offers a comfortable hold without stress or strain
- Features a stainless steel "S" channel for quick rubber replacement
- ErgoTec® Soft Rubber blade offers professional cleaning results

## Ergo Toilet Bowl Brush Complete

PART NO.: **BBWHR** CASE QTY: 5  
 CONTENTS: Handle, Holder and Two Brush Heads  
 PART NO.: **BSWHR** CASE QTY: 5  
 CONTENTS: Handle, Holder and Two Swab Heads

- Ergonomic toilet brush/swab featuring a 26" handle for improved worker safety
- Longer handle means no bending
- Hygienic, ergonomic holder is lightweight and keeps bacteria isolated
- Holder can be hand-carried or hung on cart and features a detachable base for easy emptying



## Ergo Toilet Bowl Brush Holder

PART NO.: **BBHLR** CASE QTY: 5  
 CONTENTS: Toilet Bowl Holder (brush not included)

## Ergo Toilet Bowl Brush Handle

PART NO.: **BBCOR** CASE QTY: 5  
 CONTENTS: Handle with Two Brush Heads  
 PART NO.: **BSCOR** CASE QTY: 5  
 CONTENTS: Handle with Two Swab Heads

- Increased productivity with 26" long handle and replaceable brush heads that provide a 360° cleaning surface
- Nylon bristle heads dry quickly
- Bowl cleaner can be applied directly to swab inside bowl for effective cleaning

## Ergo Toilet Bowl Replacement Heads

PART NO.: **BBRHR** CASE QTY: 5  
 CONTENTS: 2 Brush Heads  
 PART NO.: **BSRHR** CASE QTY: 5  
 CONTENTS: 2 Swab Heads

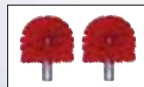

Toilet Brush



Toilet Swab



## NiftyNabber®

PART NO.: **NN40R** SIZE: 18"/45cm CASE QTY: 5

- The hygienic all-purpose grabber
- Keeps hands away from debris with its 18" long handle
- Ergonomically designed grip with smooth trigger-pull action for increased comfort and efficiency
- Access hard-to-reach areas or items with 360° rotating head
- Magnetic tip for picking up metal objects



## Desk & Table Cleaning Kit

- Minimize the spread of infectious diseases by maintaining a clean surface on desks and tabletops
- Microfiber pad reduces 96% of surface bacteria with less chemicals
- Dual-compartment bucket separates clean from dirty solution, ensuring the use of clean solution every time
- Color-coded green to prevent cross-contamination
- The tools and processes clean 4X faster, enabling more desk and table cleanings per day

PART NO.: **CK047** CAPACITY: 32 Qt./30L CASE QTY: 1

- Kit Contents:
  - COMBG SmartColor™ Dual Bucket - 32 Qt.
  - SM40G SmartColor™ EZ Flat Mop Holder
  - HH240 Henry's Handi Handle - 2'
  - MD400 SmartColor™ MicroMop 7.0 - Green (2)



## SmartColor™/Restroom Ergo Dustpan Telescopic

PART NO.: **EDTBG** COLOR: Gray SIZE: 45"x12"/114 x 30cm CASE QTY: 6  
 PART NO.: **EDTBR** COLOR: Red SIZE: 45"x12"/114 x 30cm CASE QTY: 6

- For quick removal of debris without bending
- Telescopic feature allows adjustable handles to be raised up to 10" to accommodate worker's height
- Ergonomic handle minimizes hand and wrist strain
- Broom attaches to dustpan handle for easy storage and retrieval
- Swivel dustpan opens when base hits floor and collapses without spilling its contents



Telescopic Broom

Telescopic Dustpan

## Ergo Dustpan

PART NO.: **EDPBR** COLOR: Red  
 SIZE: 33"x12"/83 x 30cm CASE QTY: 6

- For quick removal of debris without bending
- Ergonomic handle minimizes hand and wrist strain
- Broom attaches to dustpan handle for easy storage and retrieval
- Swivel dustpan opens when base hits floor, and collapses without spilling its contents





# Floor Care & Mopping

## Unger's Dual-Bucket Cleaning System

The Unger Dual Bucket System sets the standard for cleaning efficiency and hygiene. Its many distinctive ergonomic design features enhance worker productivity, reduce injuries, and increased cleaning performance.

- Side press has spring-loaded handle
- Rear-mounted pour spout and locking lower drain spout allow options for worker safety.

### SmartColor™ Floor Cleaning Kit - 32 Qt.

- Convenient floor care set, perfect for professional floor care
- Includes SmartColor™ Decal Kit to customize for designated areas or tasks

PART NO.: **FMK01** CAPACITY: 32 Qt./30L CASE QTY: 1

- Kit Contents:
- |  |                                       |
|--|---------------------------------------|
| COMBG SmartColor™ Dual Bucket - 32 Qt. | DM40B SmartColor™ Damp Mop Blue       |
| MS14G Mop Handle 140 KD                | BBWHR Ergo Toilet Bowl Brush w/Holder |
| SM40G SmartColor™ EZ Flat Mop Holder   | MF40B MicroWipe™ Heavy Duty Blue (5)  |
| MM40R SmartColor™ Micro Mop 15.0 Red   | MF40R MicroWipe™ Heavy Duty Red (5)   |

### SmartColor™ Floor Pack - 32 Qt.

PART NO.: **SCFPG** CAPACITY: 32 Qt./30L CASE QTY: 1

- Convenient floor care starter set
- Select a microfiber flat mop from Unger's wide range of products (not included)
- Includes SmartColor™ Decal Kit to customize for designated areas or tasks\*

- Kit Contents:
- |  |
|--|
| COMBG SmartColor™ Dual Bucket - 32 Qt. |
| EZ25G SmartColor™ Tele-Pole 250        |
| SM40G SmartColor™ EZ Flat Mop Holder   |



### SmartColor™ Dual Bucket - 32 Qt. Patented

PART NO.: **COMBG** COLOR: Gray CAPACITY: 32 Qt./30L CASE QTY: 1

PART NO.: **COMBR** COLOR: Red CAPACITY: 32 Qt./30L CASE QTY: 1

- Dual-compartment bucket system that separates clean and dirty water
- Empty using a rear-mounted dump spout or quick-release drain spout
- Easy-to-read fill guide for accurate chemical dilution
- Includes SmartColor™ Decal Kit to customize for designated areas or tasks (COMBG)\*

### SmartColor™ Dual Bucket - 16 Qt.

PART NO.: **COMSG** COLOR: Gray CAPACITY: 16 Qt./15L CASE QTY: 1

PART NO.: **COMSR** COLOR: Red CAPACITY: 16 Qt./15L CASE QTY: 1

- Dual-compartment bucket system that separates clean and dirty water
- Easy-to-read fill guide for accurate chemical dilution
- Ideal for smaller spaces, limited storage areas, and stairs
- Includes SmartColor™ Decal Kit to customize for designated areas or tasks (COMSG)\*

### SmartColor™ Side Bucket

PART NO.: **SMSBG** SIZE: 8.75" CASE QTY: 1

- Additional storage snaps onto side of SmartColor™ Dual Bucket - 32 Qt.
- Includes SmartColor™ Decal Kit to customize for designated areas or tasks\*

### Easy Adapter Hose

PART NO.: **WH180** SIZE: 6"/180cm CASE QTY: 20

- Fits onto standard faucet for easy bucket filling
- Hose remains firmly in place, will not detach from faucet



### SmartColor™ Micro Mop - 15.0

PART NO.: <b>MM40R</b>	COLOR: Red	SIZE: 16"/40cm	CASE QTY: 5
PART NO.: <b>MM40Y</b>	COLOR: Yellow	SIZE: 16"/40cm	CASE QTY: 5
PART NO.: <b>MM40G</b>	COLOR: Green	SIZE: 16"/40cm	CASE QTY: 5
PART NO.: <b>MM40B</b>	COLOR: Blue	SIZE: 16"/40cm	CASE QTY: 5

- Heavy-duty 15 mm pile microfiber for stone and tile floors with grout lines
- Features aggressive cleaning edges that clean with less water, less effort
- For use with Mop Holder SM40G/R
- Wash Cycles: 500



### SmartColor™ Damp Mop

PART NO.: <b>DM40R</b>	COLOR: Red	SIZE: 16"/40cm	CASE QTY: 5
PART NO.: <b>DM40Y</b>	COLOR: Yellow	SIZE: 16"/40cm	CASE QTY: 5
PART NO.: <b>DM40G</b>	COLOR: Green	SIZE: 16"/40cm	CASE QTY: 5
PART NO.: <b>DM40B</b>	COLOR: Blue	SIZE: 16"/40cm	CASE QTY: 5

- Microfiber mop, suitable for marble, linoleum, wood, and vinyl floors
- Floors dry faster than traditional mops for streak free results
- Made of durable, 100% polyester microfiber
- For use with Mop Holder SM40G/R
- Wash Cycles: 500



### SmartColor™ EZ Flat Mop Holder

PART NO.: <b>SM40G</b>	COLOR: Gray	SIZE: 16"/40cm	CASE QTY: 5
PART NO.: <b>SM40R</b>	COLOR: Red	SIZE: 16"/40cm	CASE QTY: 5

- Flat mop holder with pivoting, low-profile head
- Large 16" surface provides more direct cleaning contact, more scrubbing pressure
- Easily collapses with the touch of a button to rinse or change mop head
- Use handle socket with nylon-threaded cone or tapered handles from 21-23 mm in diameter



### SmartColor™ Micro Mop - 7.0

PART NO.: <b>MD40R</b>	COLOR: Red	SIZE: 16"/40cm	CASE QTY: 5
PART NO.: <b>MD40Y</b>	COLOR: Yellow	SIZE: 16"/40cm	CASE QTY: 5
PART NO.: <b>MD40G</b>	COLOR: Green	SIZE: 16"/40cm	CASE QTY: 5
PART NO.: <b>MD40B</b>	COLOR: Blue	SIZE: 16"/40cm	CASE QTY: 5

- Medium-duty 7 mm pile microfiber for vinyl or sealed floors without grout lines
- Features aggressive cleaning edges that clean with less water, less effort
- For use with Mop Holder SM40G/R
- Wash Cycles: 500



### SmartColor™ Spill Mop 1L

PART NO.: **MA450** COLOR: White SIZE: 16"/40cm CASE QTY: 5

- Extra absorbent microfiber, with large surface area and 14 mm pile
- Absorbs up to one liter of liquid
- For use with Mop Holder SM40G
- Wash Cycles: 500



### SmartColor™ EZ Flat Mop Holder "Drop and Mop" Feature

The "no spin" design allows the user to quickly drop the mop down and start working.

# Floor Care & Mopping



## SmartColor™ RoughMop ST45 Series

PART NO.: <b>ST45R</b>	COLOR: Red	STRAND COUNT: 32 Strands	WEIGHT: 16 oz./450g	CASE QTY: 5
PART NO.: <b>ST45Y</b>	COLOR: Yellow	STRAND COUNT: 32 Strands	WEIGHT: 16 oz./450g	CASE QTY: 5
PART NO.: <b>ST45G</b>	COLOR: Green	STRAND COUNT: 32 Strands	WEIGHT: 16 oz./450g	CASE QTY: 5
PART NO.: <b>ST45B</b>	COLOR: Blue	STRAND COUNT: 32 Strands	WEIGHT: 16 oz./450g	CASE QTY: 5

- Double-sided microfiber tube mop
- Cleaning power increased with 6" scrub pad material on headband
- Wash Cycles: 500



## SmartColor™ RoughMop ST30 Series

PART NO.: <b>ST30R</b>	COLOR: Red	STRAND COUNT: 22 Strands	WEIGHT: 11 oz./300g	CASE QTY: 5
PART NO.: <b>ST30Y</b>	COLOR: Yellow	STRAND COUNT: 22 Strands	WEIGHT: 11 oz./300g	CASE QTY: 5
PART NO.: <b>ST30G</b>	COLOR: Green	STRAND COUNT: 22 Strands	WEIGHT: 11 oz./300g	CASE QTY: 5
PART NO.: <b>ST30B</b>	COLOR: Blue	STRAND COUNT: 22 Strands	WEIGHT: 11 oz./300g	CASE QTY: 5

- Double-sided microfiber tube mop
- Cleaning power increased with 6" scrub pad material on headband
- Wash Cycles: 500



## SmartColor™ Damp Mop Pad

PART NO.: <b>DV40R</b>	COLOR: Red	SIZE: 19.5"/50cm	CASE QTY: 5
PART NO.: <b>DV40Y</b>	COLOR: Yellow	SIZE: 19.5"/50cm	CASE QTY: 5
PART NO.: <b>DV40G</b>	COLOR: Green	SIZE: 19.5"/50cm	CASE QTY: 5
PART NO.: <b>DV40B</b>	COLOR: Blue	SIZE: 19.5"/50cm	CASE QTY: 5

- High-density looped pile microfiber mop pad reduces bacteria up to 96%
- Hook and loop backing attaches securely to mop pad holder (SV40G)
- Perfect for use on health care facilities or single use applications
- Wash Cycles: 500

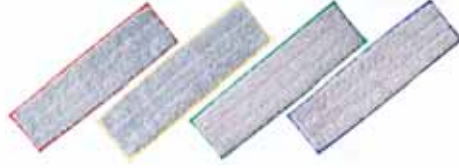

## SmartColor™ Dry/Damp Mop Pad 13.0

PART NO.: <b>DD40R</b>	COLOR: Red	SIZE: 19.5"/50cm	CASE QTY: 5
PART NO.: <b>DD40Y</b>	COLOR: Yellow	SIZE: 19.5"/50cm	CASE QTY: 5
PART NO.: <b>DD40G</b>	COLOR: Green	SIZE: 19.5"/50cm	CASE QTY: 5
PART NO.: <b>DD40B</b>	COLOR: Blue	SIZE: 19.5"/50cm	CASE QTY: 5

- 13.0 mm looped pile microfiber mop pad reduces bacteria up to 96%
- Hook and loop backing attaches securely to mop pad holder (SV40G)
- Excellent for use on floor surfaces including marble, tile, vinyl, and other smooth areas
- Wash Cycles: 300



## SmartColor™ String Mop Holder

- |                        |             |
|------------------------|-------------|
| PART NO.: <b>FC03G</b> | CASE QTY: 5 |
|------------------------|-------------|
- Heavy-duty clamp-style mop holder
  - For use with all SmartColor™ Microfiber String mop series
  - Use handle socket with nylon-threaded cone (NCA0G) or tapered handles from 21-23 mm in diameter

## Damp Mop Pad Holder

- |                        |             |
|------------------------|-------------|
| PART NO.: <b>SV40G</b> | CASE QTY: 5 |
|------------------------|-------------|
- SIZE: 18"/45cm
- Mop holder with swivel head easily glides across floors
  - Quickly attaches to SmartColor™ Damp Mop Pads using Unger's "Z" hook and loop fastening technology
  - Use with DD40 and DV40 series mop pads



## Wonder Waxer Complete

- |                        |                   |              |
|------------------------|-------------------|--------------|
| PART NO.: <b>QS140</b> | LENGTH: 56"/142cm | CASE QTY: 10 |
|------------------------|-------------------|--------------|
- Super light aluminum handle and ergonomic grip
  - Head swivels to reach difficult areas
  - Sleeve is replaceable and fits firmly on the T-Bar
  - Perfect for use on wood, gym, and commercial floors
  - Use with Pro Bucket

## Wonder Waxer Replacement Sleeve

- |                        |                  |              |
|------------------------|------------------|--------------|
| PART NO.: <b>QS010</b> | LENGTH: 17"/43cm | CASE QTY: 10 |
|------------------------|------------------|--------------|
- Replacement sleeve made out of washable, low-lint fabric
  - Snap fasteners for quick replacement and secure fit

## SmartColor™ Tele-Pole 250

- |                        |               |              |
|------------------------|---------------|--------------|
| PART NO.: <b>EZ25G</b> | SIZE: 8'/2.6m | CASE QTY: 10 |
|------------------------|---------------|--------------|
- Convenient 2-section telescoping pole
  - Extends from 4'/1.3 m to 8'/2.50 m
  - 21 mm diameter
  - Lightweight, made of aluminum
  - Includes snap-in Taper/ACME cone adapter for attaching Unger cleaning tools

## Ergo Tele-Pole

- |                        |               |              |
|------------------------|---------------|--------------|
| PART NO.: <b>EP24R</b> | SIZE: 8'/2.5m | CASE QTY: 10 |
| PART NO.: <b>EP18R</b> | SIZE: 6'/1.8m | CASE QTY: 10 |
- Convenient 2-section telescoping handle.
  - Extends from 4'/1.2 m to 6'/1.8m - 8'/2.5 m
  - 21 mm diameter
  - Includes snap-in Taper/ACME cone adapter for attaching Unger cleaning tools
  - Lightweight aluminum construction with ergonomic grip

## Mop Handle 140 KD

- |                        |              |
|------------------------|--------------|
| PART NO.: <b>MS14G</b> | CASE QTY: 10 |
|------------------------|--------------|
- SIZE: 4.5'/1.4m
- Compact mop handle "knocked down" for shipping convenience
  - Complete 3-section assembly
  - 23 mm diameter
  - Lightweight aluminum construction with ergonomic grip

## Ergo Pole

- |                        |               |              |
|------------------------|---------------|--------------|
| PART NO.: <b>HH13R</b> | SIZE: 4'/1.2m | CASE QTY: 10 |
|------------------------|---------------|--------------|
- 1 section, 21 mm diameter
  - Includes snap-in Taper/ACME threaded cone adapter for attaching Unger cleaning tools
  - Lightweight aluminum construction with ergonomic grip



## ErgoTec® Locking Cone - Red

- |                        |             |
|------------------------|-------------|
| PART NO.: <b>NCANR</b> | CASE QTY: 5 |
|------------------------|-------------|
- Securely locks select Unger tools onto pole
  - Fast tool change with quick-release button
  - Other tools attach by pressing on, snap on, or screw on



## Sanitary Brush - Red

- |                        |              |
|------------------------|--------------|
| PART NO.: <b>PB45R</b> | CASE QTY: 10 |
|------------------------|--------------|
- SIZE: 18"/45cm
- Acid-resistant, non-corroding squeegee and brush in one
  - Double black foam-rubber squeegee is perfect for drying tiles and grout lines
  - Polypropylene bristles offer effective scrubbing while being gentle on floors



## SmartColor™ Swivel Brush

- |                        |              |
|------------------------|--------------|
| PART NO.: <b>SB20G</b> | CASE QTY: 10 |
|------------------------|--------------|
- SIZE: 8" x 3"/20 x 8cm
- Durable polypropylene PET bristles offer superior scrubbing action
  - Angled bristles provide optimal cleaning of corners and edges
  - ACME threaded handle socket
  - Includes SmartColor™ Decal Kit to customize for designated areas or tasks\*



## SmartColor™ Swivel Corner Brush

- |                        |              |
|------------------------|--------------|
| PART NO.: <b>CB20G</b> | CASE QTY: 10 |
|------------------------|--------------|
- SIZE: 8.6"/22cm
- Durable polypropylene PET bristles offer superior scrubbing action
  - Angled bristles provide optimal cleaning of corners, edges, and grout lines
  - Low-profile pivoting head reduces bending and over-reaching
  - ACME threaded handle socket
  - Includes SmartColor™ Decal Kit to customize for designated areas or tasks\*

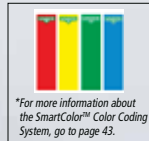

SmartColor™ Tele-Pole 250

Mop Handle 140 KD

Ergo Tele-Pole

Ergo Pole

# Floor Scrapers & Blades



## Light-Duty Scraper

PART NO.: **LH12C** LENGTH: 4'11.2m CASE QTY: 10

- For light-duty jobs, with an aluminum handle and 4" angled zinc alloy head
- Good for scraping gum, stickers, wax, etc.
- Lightweight with ergonomic grip and hang hole

## 4" Replacement Blades - Carbon Steel

PART NO.: **RB10C** SIZE: 4"/10cm CASE QTY: 10  
CASE PACK: 10 Dispensers of 10 Blades

PART NO.: **RB30C** SIZE: 4"/10cm CASE QTY: 30  
CASE PACK: 30 Dispensers of 10 Blades



- Compact handy dispenser safely stores new and used blades – easily slide in and out
- Sharp side for scraping off paint, stickers, etc., and dull side for removing cement and stucco
- For LH12C, SH00C, SH25C, STMAX



## 4" Replacement Blades - Stainless Steel

PART NO.: **RB100** SIZE: 4"/10cm CASE QTY: 10  
CASE PACK: 10 Dispensers of 10 Blades

## Medium-Duty Scraper

PART NO.: **MDSCO** LENGTH: 5'11.5m CASE QTY: 10

- For medium-duty jobs, with an aluminum handle and 6" angled zinc alloy head
- Good for industrial scraping, tape, and heavy dirt
- Ergonomic grip and hang hole

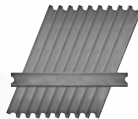

## 6" Replacement Blades

PART NO.: **MDSB0** SIZE: 6"/15cm CASE QTY: 5  
CASE PACK: 5 Tubes of 10 Blades

- For use with MDSCO
- Double-edged .036" thick carbon steel blades

## Heavy-Duty Scraper

PART NO.: **HDSS0** LENGTH: 5'11.5m CASE QTY: 1

- For heavy-duty jobs, with a steel handle and 8" angled zinc alloy head
- Good for stripping tile floors, removing carpets, and heavy-duty adhesives
- 1" diameter galvanized steel handle with ergonomic grip and hang hole



## 8" Replacement Blades

PART NO.: **HDSB0** SIZE: 8"/20cm CASE QTY: 5

- For use with HDSS0
- Double-edged .036" thick carbon steel blades

For handheld scrapers, go to page 21.

# Pro Aluminum Handles

## Pro Aluminum 1.5°

PART NO.: **AL140** LENGTH: 56"/1.4m CASE QTY: 10

- Heavy duty handle fits 1.5° taper socket, ideal for WaterWand™ squeegees

## Pro Aluminum 1.5° Knock Down

PART NO.: **AL14G** LENGTH: 56"/1.4m CASE QTY: 10

- Heavy duty handle fits 1.5° taper socket
- Rigid, fluted aluminum construction ideal for WaterWand™ squeegees



## Pro Aluminum ACME

PART NO.: **AL14A** LENGTH: 58"/1.47m CASE QTY: 10

- Heavy duty handle with threaded zinc alloy tip is ideal for Sanitary squeegees, and other products with ACME universal sockets

## Pro Aluminum 3.0°

PART NO.: **AL14T** LENGTH: 61"/1.55m CASE QTY: 10

- Heavy duty handle with ACME threaded zinc alloy tip fits 3.0° taper socket is ideal for AquaDozer™ squeegees



## WaterWand™ ACME Insert

PART NO.: **FWAIO** CASE QTY: 10

- Easily converts WaterWand™ squeegees from tapered to an ACME compatible socket for use with either type of handle



## AquaDozer® ACME Insert

PART NO.: **FAAIO** CASE QTY: 10

- Easily converts AquaDozer® squeegees from tapered to an ACME compatible socket for use with either type of handle

## Aluminum Handle Guide

All poles feature a 1" diameter anodized aluminum handle with convenient hang-up hole and fluted finish for strength. Ergonomic grip provides a comfortable hold.



### Pro Aluminum 1.5°

- Tapered



### Pro Aluminum 1.5° Knock Down (AL14G)

- Tapered



### Pro Aluminum ACME

- ACME thread



### Pro Aluminum 3.0°

- 3° Conical top

Pro Aluminum 1.5°

Pro Aluminum 1.5° Knock Down

Pro Aluminum ACME

Pro Aluminum 3.0°



# Floor Squeegees

Sanitary Standard



### Sanitary Standard

PART NO. <b>PM45A</b>	LENGTH: 18"/45cm	CASE QTY: 10
PART NO. <b>PM55A</b>	LENGTH: 22"/55cm	CASE QTY: 10

- Acid-resistant, non-corroding squeegee with natural black double foam-rubber blade with ACME thread and splash guard
- Durable threaded socket accepts ACME threaded handles
- Use with Pro Aluminum handles: ACME (AL14A) or 3.0° (AL14T)

Sanitary Brush



### Sanitary Brush

PART NO. <b>PB45A</b>	LENGTH: 18"/45cm	CASE QTY: 10
PART NO. <b>PB55A</b>	LENGTH: 22"/55cm	CASE QTY: 10

- Acid-resistant, non-corroding squeegee and brush in one
- Double black foam-rubber squeegee is perfect for drying tiles and grout lines
- Polypropylene bristles offer effective scrubbing while being gentle on floors
- Also available in red (see page 53 - PB45R)
- Use with Pro Aluminum handles: ACME (AL14A) or 3.0° (AL14T)

WaterWand™ Heavy Duty



### WaterWand™ Heavy-Duty

PART NO. <b>HMS50</b>	LENGTH: 22"/55cm	CASE QTY: 10
PART NO. <b>HM750</b>	LENGTH: 30"/75cm	CASE QTY: 10

- Removes water easily from uneven floor surfaces such as grouted tile or non-slip and broadcast grid floors with double black foam-rubber blade
- Reinforced handle socket to tackle heavy dirt
- Sturdy 20-gauge steel frame with socket clamp
- Optional ACME thread insert sold separately
- Use with Pro Aluminum handles: 1.5° (AL140) or 1.5° Knock Down (AL14G)

WaterWand™ Heavy Duty - Red



### WaterWand™ Heavy-Duty - Red

PART NO. <b>HW750</b>	LENGTH: 30"/75cm	CASE QTY: 10
-----------------------	------------------	--------------

- Removes water easily from uneven floor surfaces such as grouted tile or non-slip and broadcast grid floors with a double red neoprene foam-rubber blade
- Reinforced handle socket to tackle heavy dirt
- Sturdy 20-gauge steel frame with socket clamp
- Optional ACME thread insert sold separately
- Use with Pro Aluminum handles: 1.5° (AL140) or 1.5° Knock Down (AL14G)

WaterWand™ Standard



### WaterWand™ Standard

PART NO. <b>MW450</b>	LENGTH: 18"/45cm	CASE QTY: 10
PART NO. <b>MW550</b>	LENGTH: 22"/55cm	CASE QTY: 10

- Screw-locking socket and twin natural foam-rubber blade
- Ideal for kitchens, decks, pools, and other light jobs
- Sturdy 20 gauge steel frame with socket clamp
- Optional ACME thread insert sold separately
- Use with Pro Aluminum handles: 1.5° (AL140) or 1.5° Knock Down (AL14G)

### AquaDozer® Eco

PART NO. <b>FE450</b>	LENGTH: 18"/45cm	CASE QTY: 10
PART NO. <b>FE600</b>	LENGTH: 22"/55cm	CASE QTY: 10

- 14-gauge galvanized steel frame with black EPDM rubber
- Optional ACME threaded insert sold separately
- Use with Pro Aluminum handle: 3.0° (AL14T)

### AquaDozer® Heavy Duty

PART NO. <b>FP450</b>	LENGTH: Straight 18"/45cm	CASE QTY: 6
PART NO. <b>FP600</b>	LENGTH: Straight 24"/60cm	CASE QTY: 6
PART NO. <b>FP750</b>	LENGTH: Straight 30"/75cm	CASE QTY: 6
PART NO. <b>FP900</b>	LENGTH: Straight 36"/90cm	CASE QTY: 6
PART NO. <b>FP60C</b>	LENGTH: Curved 24"/60cm	CASE QTY: 6
PART NO. <b>FP90C</b>	LENGTH: Curved 36"/90cm	CASE QTY: 6

- For heavy-duty jobs and moving large volumes of water, mud, and debris
- Made with black EPDM rubber
- Constructed with 14-gauge powder-coated steel frame
- Reinforced zinc alloy handle socket
- Optional ACME threaded insert sold separately
- Use with Pro Aluminum handle: 3.0° (AL14T)

### AquaDozer® Max

PART NO. <b>FX600</b>	LENGTH: Straight 24"/60cm	CASE QTY: 4
PART NO. <b>FX900</b>	LENGTH: Straight 36"/90cm	CASE QTY: 4
PART NO. <b>FX60C</b>	LENGTH: Curved 24"/60cm	CASE QTY: 4
PART NO. <b>FX90C</b>	LENGTH: Curved 36"/90cm	CASE QTY: 4

- Unique curved blade maximizes cleaning performance
- Durable steel body for tough demands including flood clean up
- Rubber blade cleans and dries floor
- Best for smooth surfaces like asphalt and concrete floors
- Use with Pro Aluminum handle: 3.0° (AL14T)



Straight



Curved

AquaDozer® Eco



AquaDozer® Heavy Duty



AquaDozer® Max (Straight)



AquaDozer® Max (Curved)



# AquaDozer® Max FLOOR SQUEEGEE

Moves Up to **2X** More Compared to Competitive Squeegees

Innovative Design

The AquaDozer Max features a unique curved blade which maximizes cleaning performance.

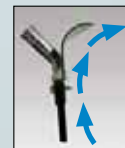

# SmartFit™ Floor Squeegees



## Innovative Technology for Professional Floor Cleaning

Solid design for all floor types. Move large volumes of debris with high quality closed cell twin foam rubber blades.

## Easy Tool Cleaning

The SmartFit™ Easy Flush & Rinse feature allows quick and easy cleaning of the squeegee socket. Large vents allow water to flush out dirt and let air back in to dry out the socket, preventing bacteria and odors to form.

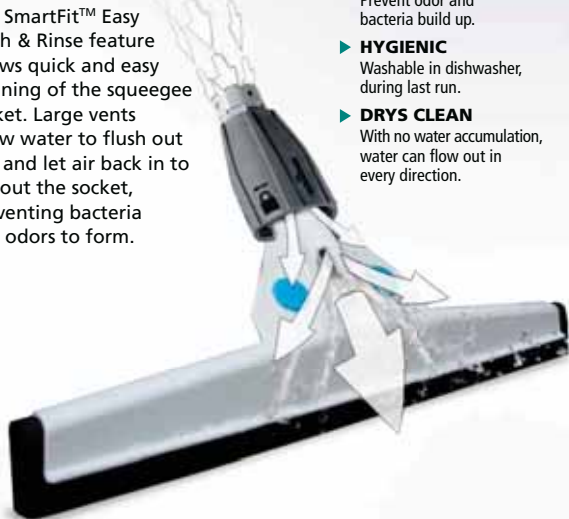

- ▶ **EASY CLEANING**  
Prevent odor and bacteria build up.
- ▶ **HYGIENIC**  
Washable in dishwasher, during last run.
- ▶ **DRYS CLEAN**  
With no water accumulation, water can flow out in every direction.

## Universal Power Socket

The Unger SmartFit™ squeegee locks onto standard handles including straight, tapered, thread and non thread tips.

- ▶ **ERGONOMIC DESIGN**  
Collar designed for easy tightening and loosening of the socket.
- ▶ **HIGH QUALITY MATERIAL**  
Strongest floor squeegee — four times stronger than others. Reinforced synthetic material and glass filled nylon for extra long durability.
- ▶ **SECURE FIT**  
Squeegee handles won't fall off or wobble.

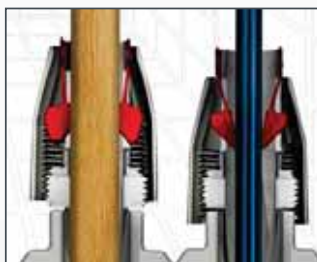

## SmartColor Coding System

Use the flexible coding chips to designate squeegees to specific cleaning zones. This will prevent cross-contamination.

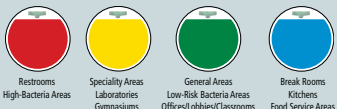

Restrooms  
High Bacteria Areas
  Speciality Areas  
Laboratories  
Gymnasiums
  General Areas  
Low-Risk Bacteria Areas  
Offices/Lobbies/Classrooms
  Break Rooms  
Kitchens  
Food Service Areas



## SmartFit™ WaterWand™ Heavy Duty

PART NO.:	HM22A	LENGTH:	22"/55cm	CASE QTY.:	10
PART NO.:	HM30A	LENGTH:	30"/75cm	CASE QTY.:	10
PART NO.:	HM30K	LENGTH:	30"/75cm	CASE QTY.:	1

- Heavy duty usage floor squeegee.
- Removes water easily from uneven floor surfaces such as grouted tile or non-slip and broadcast grid floors with double black foam-rubber blade



## SmartFit™ WaterWand™ Heavy Duty - Red

PART NO.:	HW30A	LENGTH:	30"/75cm	CASE QTY.:	10
-----------	-------	---------	----------	------------	----

- Heavy duty usage floor squeegee.
- Removes water easily from uneven floor surfaces, such as grouted tile, or non-slip and broadcast grid floors with double red, chemical resistant neoprene foam-rubber blade



## SmartFit™ WaterWand™ Standard

PART NO.:	MW18A	LENGTH:	18"/45cm	CASE QTY.:	10
PART NO.:	MW22A	LENGTH:	22"/55cm	CASE QTY.:	10

- General purpose floor squeegee. Twin natural foam-rubber blade.
- Standard version for lighter jobs, kitchens, decks, pools, etc.

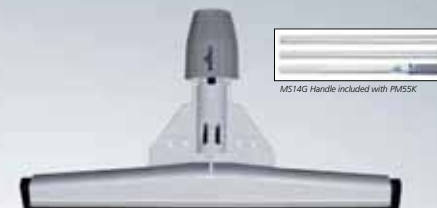

## SmartFit™ Sanitary Standard

PART NO.:	PM45G	LENGTH:	18"/45cm	CASE QTY.:	10
PART NO.:	PM55G	LENGTH:	22"/55cm	CASE QTY.:	10
PART NO.:	PM55K	LENGTH:	22"/55cm	CASE QTY.:	1

- Plastic body sanitary floor squeegee ideal for food service; won't rust
- Acid-resistant, non-corroding polypropylene frame for use where metal is undesirable
- Plastic frame provides increased hygiene



## SmartFit™ Sanitary Brush

PART NO.:	PB55G	LENGTH:	22"/55cm	CASE QTY.:	10
-----------	-------	---------	----------	------------	----

- Squeegee and brush in one. Brush loosens dirt in grouted floors
- Acid-resistant, non-corroding polypropylene frame for use where metal is undesirable
- Double black foam-rubber squeegee is perfect for drying tiles and grout lines
- Polypropylene bristles offer effective scrubbing while being gentle on floors



# Litter Removal

When litter is a problem, Unger's cleaning tools are your solution. These tools and accessories are designed for safety and efficiency, minimizing strain and injury. No bending, no backaches. Great for retrieving out of reach objects high or low.

Ergonomic handles and lightweight design help get cleaning jobs done fast. Keep your grounds spotless with these high-quality litter removal tools.



NiftyNabber® Trigger Grip

NiftyNabber® Bagger

People's Paper Picker Pin

NiftyNabber® Pro

Neoprene Gloves

## Litter Removal

### NIFTYNABBER® PRODUCTS

#### NiftyNabber® Pro

PART NO. <b>NN400</b>	LENGTH: 18" / 45cm	CASE QTY: 5
PART NO. <b>NN900</b>	LENGTH: 36" / 90cm	CASE QTY: 10
PART NO. <b>NN140</b>	LENGTH: 51" / 130cm	CASE QTY: 5
PART NO. <b>NN960</b>	LENGTH: 96" / 250cm	CASE QTY: 6

- Strong enough for heavy-duty work, light enough to protect from back and arm strain
- Shaft made from durable steel for long-lasting, dependable use

#### NiftyNabber® Trigger Grip

PART NO. <b>NT060</b>	LENGTH: 24" / 60cm	CASE QTY: 5
PART NO. <b>NT080</b>	LENGTH: 32" / 80cm	CASE QTY: 5
PART NO. <b>NT090</b>	LENGTH: 36" / 90cm	CASE QTY: 5

- Comfortable grip with smooth, trigger-pull action
- Access hard-to-reach areas or items with 360° rotating head
- Magnetic tip allows user to pick up small metal objects, up to .25 lbs
- Lightweight aluminum shaft, designed to decrease fatigue and make waist-high and overhead use easier

#### People's Paper Picker Pin

PART NO. <b>PPPP0</b>	LENGTH: 42" / 100cm	CASE QTY: 10
-----------------------	---------------------	--------------

- Effective waste removal using strong metal pin
- Easily picks up litter such as paper, cans, and plastic cups

#### Replacement Pin Plugs

PART NO. <b>PINPO</b>	CASE QTY: 10
-----------------------	--------------

#### NiftyNabber® Bagger

PART NO. <b>NB300</b>	SIZE/CAPACITY: 23" x 27" / 40 Gal.	CASE QTY: 1
-----------------------	------------------------------------	-------------

- Bagger collapses and secures for compact shipping and easy storage
- Bottom drainage holes make rinsing out easy
- Uses standard 55 gal. trash bags (weight capacity: 65 lbs)
- Sturdy web handles and rugged bottom allow easy dragging over pavement

#### Neoprene Gloves

PART NO. <b>GLOV2</b>	SIZE: Large	CASE QTY: 10
PART NO. <b>GLOV3</b>	SIZE: XLarge	CASE QTY: 10
PART NO. <b>GLOV4</b>	SIZE: XXLarge	CASE QTY: 10

- Neoprene exterior, plus interior foam insulation
- Textured palm provides a non-slip grip
- Hook and loop strap provides a secure fit

### NiftyNabber® Trigger Grip Design Advantages



**Rotating Head**  
Access hard-to-reach areas or items with 360° rotating head.



**Magnetic Tip**  
Use the grabber to pick up small metal objects - up to .25 lbs.



**Ergonomic Design**  
Ergonomically designed grip with smooth trigger-pull action for increased comfort and efficiency.



**Trigger Grip**  
The rubber claws allow users to pick up and hold small objects.



# Spare Parts & Accessories

Unger's selection of parts and accessories will ensure that your professional grade cleaning tools work at peak performance. Get the most out of your investment by properly storing and maintaining tools, ensuring they are always ready for use.

Our accessories are designed and manufactured with the highest level of care: with an Unger product, you can trust that every detail is reliable.

## nLite® HydroPower™ & nLite Systems

### Indoor Window Cleaning

### Telescopic Poles/ Dusting & Maintenance/ Floor Care

### Restroom<sub>x</sub> Cart System

### Floor Mopping/ Restroom Cleaning

## nLite HydroPower

Key Code	Part #	Description	Case Qty.
A	18641	Outlet with O-Ring	1
B	18481	Outlet Hose Quick Connect	1
C	DIPRE	FloWater™ Unit	1
D	18482	Inlet On/Off Valve	1
E	DISKT	O-Rings (5), Care Resolution	1
F	DITCP	Top Cap Assembly	1
G	DITDS	TDS Meter	1
H	19034	Inlet Quick Connect	1

## HiFlo™ nLite WaterFed Pole System



HiFlo™ nLite HiMod Carbon Poles					HiFlo™ nLite Hybrid Poles				
Part No.	Product Description	Compatible With	Pole Type	Case Qty.	Part No.	Product Description	Compatible With	Pole Type	Case Qty.
17254	26mm Master Section with Yellow Clamp	UC67G	Master	1	17267	35mm Master Section Base with Gray/Yellow Clamps	HT67G	Master	1
17260	29mm Master Section with Gray Clamp	UC67G	Master	1	17264	32mm Master Section with Gray Clamp	HT67G	Master	1
17266	32mm Master Section with Gray Clamp	UC67G	Master	1	17258	29mm Master Section with Gray Clamp	HT67G	Master	1
17269	35mm Master Section with Gray/Yellow Clamps	UC67G	Master	1	17252	26mm Master Section with Yellow Clamp	HT67G	Master	1
17279	32mm Extension Section with Yellow Connection Guide Ring	UC35G	Extension	1	17277	32mm Extension Section with Yellow Connection Guide Ring	HT35G	Extension	1
17396	35mm Extension Section with Gray/Yellow Clamps	UC35G	Extension	1	17395	35mm Extension Section with Gray/Yellow Clamps	HT35G	Extension	1

HiFlo™ nLite Carbon Poles					HiFlo™ nLite Aluminum Poles				
Part No.	Product Description	Compatible With	Pole Type	Case Qty.	Part No.	Product Description	Compatible With	Pole Type	Case Qty.
17268	35mm Master Section with Gray/Yellow Clamps	CT67G	Master	1	17828	26mm Master Section with Yellow Clamp	AN45U	Master	1
17265	32mm Master Section with Gray Clamp	CT67G	Master	1	17829	29mm Master Section with Gray Clamp	AN45U	Master	1
17259	29mm Master Section with Gray Clamp	CT67G	Master	1	17830	32mm Master Section with Gray Clamp	AN45U	Master	1
17253	26mm Master Section with Yellow Clamp	CT67G	Master	1	17831	35mm Master Section with Gray/Yellow Clamp	AN45U	Master	1
17278	32mm Extension Section with Yellow Connection Guide Ring	CT35G	Extension	1	17824	26mm Master Section with Yellow Clamp	AN60U	Master	1
17394	35mm Extension Section with Gray/Yellow Clamps	CT35G	Extension	1	17825	29mm Master Section with Gray Clamp	AN60U	Master	1
					17826	32mm Master Section with Gray Clamp	AN60U	Master	1
					17827	35mm Master Section with Gray/Yellow Clamp	AN60U	Master	1
					17832	32mm Extension Section with Yellow Connection Guide Ring	AN30U	Extension	1
					17833	35mm Extension Section with Gray/Yellow Clamp	AN30U	Extension	1



**HiFlo™ nLite Replacement Parts**

 <b>Hose Clips</b> Part No.: 17149 Case Qty.: 1	 <b>26mm Clamp (Master, Yellow)</b> Part No.: 17152 Case Qty.: 1	 <b>29mm Clamp (Master, Gray)</b> Part No.: 17157 Case Qty.: 1	 <b>32mm Clamp (Master, Gray)</b> Part No.: 17162 Case Qty.: 1	 <b>35mm Clamp (Master/Extension)</b> Part No.: 17169 Case Qty.: 1
 <b>35mm Clamp (Master/Extension, Gray)</b> Part No.: 17170 Case Qty.: 1	 <b>Brush Socket</b> Part No.: NLBRS Case Qty.: 1	 <b>nLite Endcap</b> Part No.: TMECP Case Qty.: 1	 <b>nLite Carrying Bag</b> Part No.: NLBA1 Case Qty.: 1	 <b>Soap Dispenser</b> Part No.: HCDUS Case Qty.: 1
<b>Outdoor Window Cleaning</b>				









**Window/Glass Cleaning**

 <b>ErgoTec® Set Bag</b> Part No.: 13313 Case Qty.: 1 Compatible With: ETSE1	 <b>Trans-Set Cleaning Kit Bag</b> Part No.: 10804 Case Qty.: 1 Compatible With: TRS00	 <b>Stingray O-Ring</b> Part No.: 18863 Case Qty.: 1 Compatible With: Stingray	 <b>Stingray Battery Cover</b> Part No.: 19352 Case Qty.: 1 Compatible With: Stingray	 <b>Stingray Top Cover</b> Part No.: 19353 Case Qty.: 1 Compatible With: Stingray	 <b>Stingray Handheld (Unit Only)</b> Part No.: 19168 Case Qty.: 1 Compatible With: Stingray
 <b>Visa Head</b> (Holds end piece and washer sleeve) Part No.: 10962 Case Qty.: 1 Compatible With: VP Series	 <b>Versa Head (Holds Channel)</b> Part No.: 10483 Case Qty.: 1 Compatible With: VP Series	 <b>VisaVersa® Handle/Grip</b> Part No.: 10964 Case Qty.: 1 Compatible With: VP Series	 <b>Washer Handle</b> Part No.: 10969 Case Qty.: 1 Compatible With: T-bar	 <b>Replacement Washer</b> Part No.: 10966 Size: 10" Part No.: 10967 Size: 14" Part No.: 10968 Size: 18" Case Qty.: 1 (All sizes) Compatible With: T-bar (End Piece)	 <b>Velcro Strip Replacement</b> Part No.: 20184 Case Qty.: 1 Compatible With: PHH20/PHH20

**Scrapers**

 <b>Cover - Maxi Scraper</b> Part No.: STMXC Case Qty.: 1 Compatible With: STMXX	 <b>Glass Scraper Cover - 4"</b> Part No.: EGC10 Case Qty.: 1 Compatible With: EG100	 <b>Glass Scraper Cover - 6"</b> Part No.: EGC15 Case Qty.: 1 Compatible With: EG150	 <b>Blade Holder, ErgoTec Glass - 4"</b> Part No.: EGH10 Case Qty.: 1 Compatible With: EG100	 <b>Blade Holder, ErgoTec Glass - 6"</b> Part No.: EGH15 Case Qty.: 1 Compatible With: EG150	 <b>Blade Holder, ErgoTec Ninja - 4"</b> Part No.: 18108 Case Qty.: 1 Compatible With: EN100/ENH10
 <b>Blade Holder, ErgoTec Ninja - 6"</b> Part No.: 18098 Case Qty.: 1 Compatible With: EN150/ENH15	 <b>ErgoTec Ninja Scraper Cover - 4"</b> Part No.: 18103 Case Qty.: 1 Compatible With: EN100/ENH10	 <b>ErgoTec Ninja Scraper Cover - 6"</b> Part No.: 18085 Case Qty.: 1 Compatible With: EN150/ENH15	 <b>ErgoTec Holster Retainer Clip &amp; Screw</b> Part No.: 18459 Case Qty.: 1 Compatible With: HT150/ENH10/ENH15	 <b>ErgoTec Holster Belt Clip</b> Part No.: 18460 Case Qty.: 1 Compatible With: HT150/ENH10/ENH15	 <b>UNGER Sticker</b> Part No.: 18405 Case Qty.: 1 Compatible With: Ninja Scraper

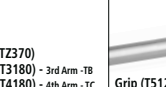
**Telescopic Poles**

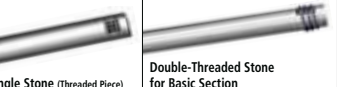
<b>Smooth Inside Pole (for 21mm poles)</b> Part No.: 12713 Compatible With: EZ250/ED370/TZ250 Part No.: 12714 Compatible With: ED450 Part No.: 12715 Compatible With: ED550/TZ370 Part No.: 12717 Compatible With: EZ250 Part No.: 12718 Compatible With: ED900 (parts must be shipped by truck) Part No.: 13908 Compatible With: EZ400		<b>Smooth Fluted Pole (for 25mm poles)</b> Part No.: 12720 Compatible With: EZ250/ED370 Part No.: 12721 Compatible With: ED450 Part No.: 13905 Compatible With: EZ400 Part No.: 13907 Compatible With: ED900 (parts must be shipped by truck) Part No.: 13951 Compatible With: ED550		<b>Large Fluted Pole (for 29mm poles)</b> Part No.: 12722 Compatible With: ED370 Part No.: 12729 Compatible With: ED550 Part No.: 13344 Compatible With: ED900 (parts must be shipped by truck)	
 <b>Outside Locking Collar</b> Part No.: 10914 Case Qty.: 1 Size: Small Pole Size: 25mm Part No.: 10916 Case Qty.: 1 Size: Large Pole Size: 29mm Compatible With: OptiLoc Poles	 <b>Inside Locking Collar (Gray)</b> Part No.: 12686 Case Qty.: 1 Size: Small Pole Size: 25mm Part No.: 10917 Case Qty.: 1 Size: Large Pole Size: 29mm Compatible With: OptiLoc Poles	 <b>Grip (Green)</b> Part No.: 10868 Case Qty.: 1 Pole Size: 25mm Part No.: 10870 Case Qty.: 1 Pole Size: 29mm Compatible With: Poles	 <b>Locking Collar</b> Part No.: 10949 3rd Arm - TB (3-sect) Part No.: 10952 4th Arm - TC (4-sect) Part No.: 10953 5th Arm - TD (5-sect) Case Qty.: 1 Compatible With: TelePlus Poles	 <b>Locking Collar Classic -TP (2-sect)</b> Part No.: 10956 Case Qty.: 1 Compatible With: TelePlus Poles	
 <b>Grip</b> Part No.: 13764 (TZ370) Part No.: 13765 (T3180) - 3rd Arm -TB Part No.: 13766 (T4180) - 4th Arm -TC Case Qty.: 1 Compatible With: TelePlus Poles	 <b>Grip (T5120 - T5180) 5th Arm -TD</b> Part No.: 10954 Case Qty.: 1 Compatible With: TelePlus Poles	 <b>Inside Single Stone (Threaded Piece)</b> Part No.: 10950 Case Qty.: 1 Compatible With: TelePlus Poles	 <b>Double-Threaded Stone for Basic Section</b> Part No.: 10958 Case Qty.: 1 Compatible With: TelePlus Poles		

**Dusting & Maintenance**

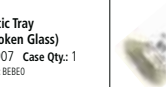
 <b>BEBE - Plastic Tray (Catches Broken Glass)</b> Part No.: 10907 Case Qty.: 1 Compatible With: BEBEO	 <b>Flood Sucker - Plastic Cup</b> Part No.: 10921 Case Qty.: 1 Compatible With: F5000
--	--

**Floor Care**

 <b>Blade Cover - 4" Scraper</b> Part No.: 10947 Case Qty.: 1 Compatible With: LH12C/SH00C/SH25C	 <b>Blade Cover - 6" Scraper</b> Part No.: 10863 Case Qty.: 1 Compatible With: MD500	 <b>Blade Cover - 8" Scraper (Clear)</b> Part No.: 10864 Case Qty.: 1 Compatible With: HD500
 <b>Screws</b> Part No.: 18191 Case Qty.: 1 Compatible With: LH12C/SH00C/SH25C	 <b>ProBucket Handle for QB220</b> Part No.: 10941 Case Qty.: 1 Compatible With: QB220	 <b>AquaDozer® Replacement Rubber - 24"</b> Part No.: FRR60 Case Qty.: 1 Compatible With: FP600/FP60C
 <b>AquaDozer® Replacement Rubber - 36"</b> Part No.: FRR90 Case Qty.: 1 Compatible With: FP900/FP90C	 <b>EndCap for Hold Up</b> Part No.: 12066 Side: Left Case Qty.: 1 Part No.: 12068 Side: Right Case Qty.: 1 Compatible With: HU450/HU900	 <b>Rubber for Hold Up</b> Part No.: 10971 Case Qty.: 1 Compatible With: HU450/HU900
 <b>Hang Up Slide-In "Claws"</b> Part No.: 14715 Case Qty.: 1 Compatible With: HD350/HD700		

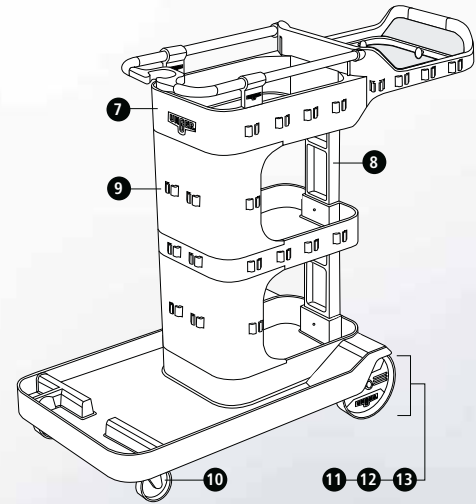
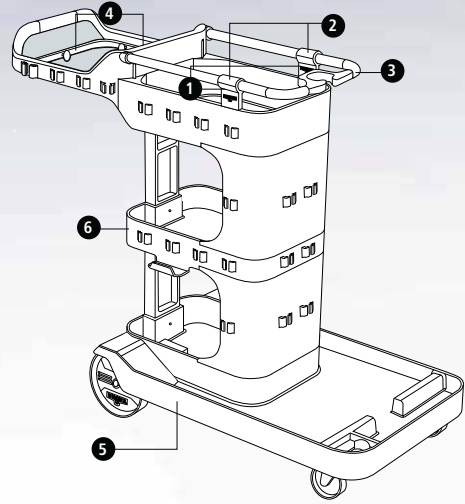
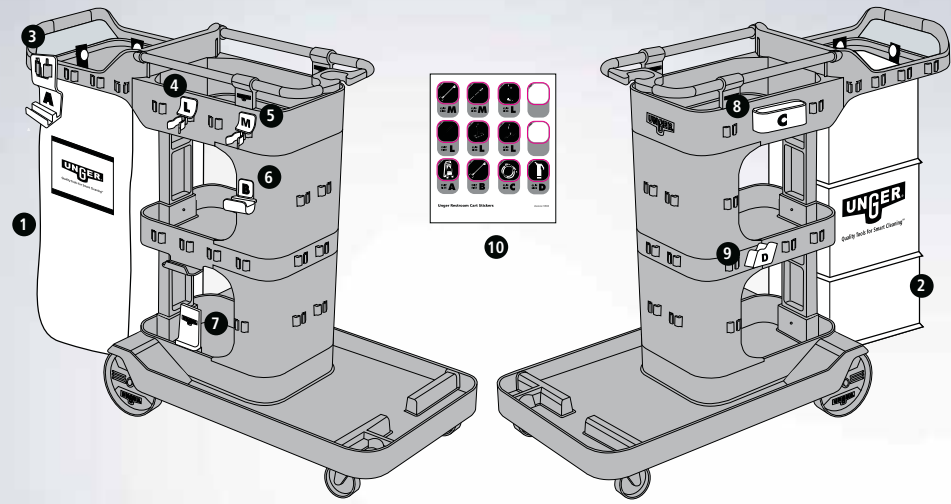

**RestroomRₓ Cart System -  
Plastic Cart Components**

<p><b>PART 1</b></p> <p>Rail Bracket Part No.: 18002 Case Qty.: 1</p>	<p><b>PART 2</b></p> <p>Rail Bracket Cover Part No.: 18003 Case Qty.: 1</p>
<p><b>PART 3</b></p> <p>Rail Mop Holder with Rails Part No.: 18018 Case Qty.: 1</p>	<p><b>PART 4</b></p> <p>Trash Bag Wire Part No.: 18008 Case Qty.: 1</p>
<p><b>PART 5</b></p> <p>Cart Base (complete with wheels) Part No.: 18493 Case Qty.: 1</p>	<p><b>PART 6</b></p> <p>Cart Middle Shelf Part No.: 17990 Case Qty.: 1</p>
<p><b>PART 7</b></p> <p>Cart Top Shelf (without handrail) Part No.: 17991 Case Qty.: 1</p>	<p><b>PART 8</b></p> <p>Cart Center Support Part No.: 17992 Case Qty.: 1</p>
<p><b>PART 9</b></p> <p>Cart Front Curve Wall Part No.: 17989 Case Qty.: 1</p>	<p><b>PART 10</b></p> <p>Front Casters Part No.: 18011 Case Qty.: 1</p>
<p><b>PART 11</b></p> <p>Back Axel Part No.: 18015 Case Qty.: 1</p>	<p><b>PART 12</b></p> <p>Back Wheel Part No.: 18012 Case Qty.: 1</p>
<p><b>PART 13</b></p> <p>Axel Cap Part No.: 18017 Case Qty.: 1</p>	<p><b>PART 14</b></p> <p>Toilet Bowl Brush Holder Base Part No.: 18369 Case Qty.: 1</p>
<p><b>PART 15</b></p> <p>Toilet Bowl Brush Holder with Base Part No.: 18001 Case Qty.: 1</p>	

**RestroomRₓ Cart System - Bag/Clip Attachments**

<p><b>PART 1</b></p> <p>Vinyl Trash Bag Part No.: RRBAG Case Qty.: 1</p>	<p><b>PART 2</b></p> <p>Supply Module Storage Bag Part No.: RRMOD Case Qty.: 1</p>	<p><b>PART 3</b></p> <p>Restroom Floor Sign Holder Part No.: RRF5H Case Qty.: 1</p>	<p><b>PART 4</b></p> <p>Toilet Clips - Large Part No.: RRTLGL Case Qty.: 5</p>	<p><b>PART 5</b></p> <p>Toilet Clips - Medium Part No.: RRTMD Case Qty.: 5</p>
<p><b>PART 6</b></p> <p>Small Tool Shelf - Nabber Part No.: RRTS Case Qty.: 1</p>	<p><b>PART 7</b></p> <p>Lobby Dust Pan Kickplate Part No.: RRLDP Case Qty.: 1</p>	<p><b>PART 8</b></p> <p>Easy Adapter Hose Holder Part No.: RRFHH Case Qty.: 1</p>	<p><b>PART 9</b></p> <p>Toilet Bowl Holder Clip Part No.: 18370 Case Qty.: 1</p>	<p><b>PART 10</b></p> <p>Toilet Icons Sticker Sheet Part No.: RRICN Case Qty.: 1</p>

## Floor Mopping/Restroom Cleaning

	<b>Side Press Handle</b> (White/Gray Handle with Gray e-clip) Part No.: 18393 Case Qty.: 1 Compatible With: COMBG/COMSG		<b>SmartColor™ Press &amp; Bucket Handle</b> (White/Gray) Part No.: SPREG Case Qty.: 1 Compatible With: COMBG/COMSG COMSG/COMSR		<b>Press Spring</b> Part No.: 14001 Size: 1" Spring Case Qty.: 1 Part No.: 18211 Size: 3" Spring Case Qty.: 1 Part No.: 18210 Size: 1" S-Hook Case Qty.: 1 Compatible With: COMBG/COMBR/COMSG/COMSR
	<b>Side Press Handle</b> (White/Gray Handle with Red e-clip) Part No.: 18394 Case Qty.: 1 Compatible With: COMBR/COMSR		<b>SmartColor™ Press &amp; Bucket Handle</b> (White/Gray) Part No.: SPRED Case Qty.: 1 Compatible With: COMBG/COMSG COMSG/COMSR		<b>Press Spring</b> Part No.: 18514 Case Qty.: 1 Contents: 1" S-Hook & 2" Spring in Polybag Compatible With: COMBG/COMBR/COMSG/COMSR
	<b>Gray Divider</b> Part No.: 17655 Case Qty.: 1 Compatible With: COMSR/COMSG		<b>Caster Sleeves</b> Part No.: 18163 Case Qty.: 1 Compatible With: COMSR/COMSG		<b>Small Caster</b> Part No.: 18199 Case Qty.: 1 Compatible With: COMSR/COMSG
			<b>Gray Caster</b> Part No.: 17891 Case Qty.: 1 Compatible With: COMBR/COMBG		
	<b>E-Clip</b> Part No.: 13381 Case Qty.: 1 Compatible With: Bucket Press Handle/ Mop Holder		<b>Side Leg for 30L Bucket</b> Part No.: 13661 Case Qty.: 1 Part No.: 13662 Case Qty.: 1 Compatible With: COMBG/COMBR		<b>Drain Plug for Big Bucket</b> Part No.: 18192 Case Qty.: 1 Compatible With: COMBG
	<b>Broom Head for Dustpan</b> Part No.: 15494 Case Qty.: 1 Compatible With: EDPBR/EDTBR/EDTGB		<b>Dustpan</b> Part No.: 12931 Case Qty.: 1 Compatible With: EDTBG/EDTBR/EDPBR		<b>Broom Handle for Dustpan</b> Part No.: 15492 Case Qty.: 1 Compatible With: EDPBR
	<b>Handle for Telescopic Dustpan - Gray</b> Part No.: 17127 Case Qty.: 1 Compatible With: EDTBG		<b>Handle for Telescopic Broom - Gray</b> Part No.: 17128 Case Qty.: 1 Compatible With: EDTBG		<b>Telescopic Dustpan Handle with Yoke - Gray</b> Part No.: 17926 Case Qty.: 1 Compatible With: EDTBG
	<b>Handle for Telescopic Dustpan - Red</b> Part No.: 17125 Case Qty.: 1 Compatible With: EDTBR		<b>Handle for Telescopic Broom - Red</b> Part No.: 17126 Case Qty.: 1 Compatible With: EDTBR		<b>Telescopic Dustpan Handle with Yoke - Red</b> Part No.: 17927 Case Qty.: 1 Compatible With: EDTBR
	<b>Grips for Dustpan Handle - Gray</b> Part No.: 18193 Case Qty.: 1 Compatible With: EDTBG		<b>Grips for Broom Handle - Gray</b> Part No.: 18194 Case Qty.: 1 Compatible With: EDTBG		<b>Grip</b> Part No.: 10892 Case Qty.: 1 Compatible With: Poles
	<b>Grips for Dustpan Handle - Red</b> Part No.: 18195 Case Qty.: 1 Compatible With: EDTBR		<b>Grips for Broom Handle - Red</b> Part No.: 18196 Case Qty.: 1 Compatible With: EDTBR		<b>SmartColor™ Stickers</b> Part No.: SCCR0 Size: Round Case Qty.: 1 Part No.: SCCS0 Size: Square Case Qty.: 1 Compatible With: SmartColor Products
	<b>Cone Adapter (Green)</b> Part No.: NCA00 Case Qty.: 5 Compatible With: Poles		<b>Cone Adapter (Gray)</b> Part No.: NCA0G Case Qty.: 5 Compatible With: Poles		<b>Cone Adapter (Red)</b> Part No.: NCA0R Case Qty.: 5 Compatible With: Poles
	<b>Spring for Nylon Cone Adapters</b> Part No.: 11076 Case Qty.: 1 Compatible With: NCA00/NCA0G/NCA0R		<b>Locking Collar (Red)</b> Part No.: 10894 Case Qty.: 1 Compatible With: EP24R		<b>Sprayer for the Sparyer On A Belt</b> Part No.: 12946 Case Qty.: 1 Compatible With: SOABG
	<b>SmartColor™ Mop Holder - Side Flip</b> Part No.: 19264 Case Qty.: 1 Compatible With: SM40G/SM40R		<b>Velcro Replacement Strips for SV40G Mop Pad Holder</b> Part No.: 15377 Case Qty.: 1 Compatible With: SV40G		<b>EndClips for SV40G Mop Pad Holder (2 Pack)</b> Part No.: 15090 Case Qty.: 1 Compatible With: SV40G

## Product Index

New Items Highlighted in Green

Part No.	Product Name	Page No.	Part No.	Product Name	Page No.
<b>A</b>			<b>D</b>		
AC Series	ErgoTec® Ninja Aluminum Channels	18	DD40 Series	SmartColor™ Dry/Damp Mop Pad 13.0	54
AFJET	HiFlo™ Thread Adapter	31	DIWL4	Casters for Tank	10
AL140	Pro Aluminum 1.5°	57	DM40 Series	SmartColor™ Damp Mop	53
AL14A	Pro Aluminum ACME	57	DS Series	StarDuster® Pro Duster/Lambwool Replacement Sleeves	35
AL14G	Pro Aluminum 1.5° Knock Down	57	DV40 Series	SmartColor™ Damp Mop Pad	54
AL14T	Pro Aluminum 3.0°	57	<b>E</b>		
AN30G	HiFlo™ nLite® Aluminum Extension Pole	11	E3000	ErgoTec® Ninja Squeegee Handle - 30"	18
AN45G	HiFlo™ nLite® Aluminum Master Pole - 14'	11	EC45R	SmartColor™ Washer 15.0	48
AN60K	HiFlo™ nLite® Aluminum 20' Kit	12	ED Series	OptiLoc™ 3-Section Poles	38
AN60G	HiFlo™ nLite® Aluminum Master Pole - 20'	11	EDPBR	Ergo Dustpan	49
AUSQ0	Auto Squeegee	19	EDTBG	SmartColor™ Dustpan Telescopic - Gray	49
<b>B</b>			EDTBR	Restroom Ergo Dustpan Telescopic - Red	49
BB010	ErgoTec® Ninja Bucket On A Belt	25	EG Series	ErgoTec® Glass Scraper	21
BB020	Classic Bucket On A Belt	25	EH Series	ErgoTec® T-Bar	17
BBCOR	Ergo Toilet Bowl Brush (w/ Two Heads)	48	EN Series	ErgoTec® Ninja Squeegee - Complete	18
BBHLR	Ergo Toilet Bowl Tool Holder	48	EN000	ErgoTec® Ninja Squeegee Handle - 40"	18
BBHRH	Ergo Toilet Bowl Brush Replacement Heads	48	EN100	ErgoTec® Ninja Scraper - 4"	23
BBWHR	Ergo Toilet Bowl Brush with Holder (w/ Two Heads)	48	EN150	ErgoTec® Ninja Scraper - 6"	23
BEBE0	The Bebbe	37	ENB10	Premium Glass Scraper Blades - 4"	23
BS010	Sticky Fingers Bulb Changer	37	ENB15	Premium Glass Scraper Blades - 6"	23
BSCOR	Ergo Toilet Bowl Swab (w/ Two Heads)	48	ENH10	ErgoTec® Ninja Scraper Combo - 4"	23
BSDHR	ErgoTec® Double Holster	25	ENH15	ErgoTec® Ninja Scraper Combo - 6"	23
BSPOU	ErgoTec® Pouch	25	EP18R	Ergo Tele-Pole - 6'	55
BSRHR	ErgoTec® Belt	25	EP24R	Ergo Tele-Pole - 8'	55
BSWHR	Ergo Toilet Bowl Swab with Holder (w/ Two Heads)	48	ES Series	ErgoTec® Squeegee	19, 48
<b>C</b>			ETG00	ErgoTec® Squeegee Handle	20
CB20G	SmartColor™ Swivel Corner Brush	55	ETSET	ErgoTec® Set	24
CEDUG	StarDuster® Pro Ceiling Fan Duster	35	ETX00	ErgoTec® XL Handle	20
CJA00	Cranked Joint Angle Adapter - Zinc	37	EW35G	Ergo Wall Squeegee with ACME Grip	19
CJN00	Cranked Joint Angle Adapter - Plastic	37	EW35R	Ergo Wall Squeegee with ACME Grip	48
CK047	Desk and Table Cleaning Kit	49	EZ Series	OptiLoc™ 2-Section Poles	38
CK054	SpeedClean™ Window Kit	49	EZ25G	SmartColor™ Tele-Pole 250	55
CK055	High Access Dusting Starting Kit	30	<b>F</b>		
COBW0	CobWeb Duster Brush	36	FAA10	AquaDozer® ACME Insert	57
COMBG	SmartColor™ Dual Bucket - 32 Qt. (Gray)	52	FC03G	SmartColor™ String Mop Holder	54
COMBR	SmartColor™ Dual Bucket - 32 Qt. (Red)	52	FE Series	AquaDozer® Eco	59
COMSG	SmartColor™ Dual Bucket - 16 Qt. (Gray)	52	FIX10	FIX1-Clamp	37
COMSR	SmartColor™ Dual Bucket - 16 Qt. (Red)	52	FMK01	SmartColor™ Floor Cleaning Kit - 32 Qt.	57
CT35G	HiFlo™ nLite® Carbon Extension Pole	11	FP Series	AquaDozer® Heavy-Duty	59
CT67G	HiFlo™ nLite® Carbon Master Pole	11	FR Series	EasyGlide Glass Cleaner	24
			FS000	Flood Sucker Bulb Changer	37
			FTGOS	HiFlo™ Multilink Adapter	14
			FTLCA	HiFlo™ Multilink Cone Adapter	14
			FTTHR	HiFlo nLite Multilink Thread Adapter	14
			FTMGL	HiFlo™ Multilink Gooseneck - Long	14

Part No.	Product Name	Page No.
----------	--------------	----------

## F

FTPLS	HiFlo™ Multilink Extension	14
FTYAD	HiFlo™ Multilink Y-Adapter	14
FWA10	WaterWand™ ACME Inset	57
<b>FX Series</b>	<b>AquaDozer® Max</b>	<b>59</b>

## G

GC Series	Brass Channel for GoldenClip®	20
GLOV Series	Neoprene Gloves	63
GS Series	GoldenClip® Brass Squeegee	19
GS000	GoldenClip® Brass Handle	20

## H

HDSB0	8" Replacement Blades	56
HDSS0	8" Heavy-Duty Scraper	56
HF40K	PureWater Conversion Kit	9
HFNL	HiFlo™ nLite® Locking Cone Adapter	37
HH13R	Ergo Pole	55
HH240	Henry's Handi Handle	38
HM Series	WaterWand™ Heavy Duty	58
HM22A	SmartFit™ WaterWand™ Heavy Duty - 22"	61
HM30A	SmartFit™ WaterWand™ Heavy Duty - 30"	61
HM30K	SmartFit™ WaterWand™ Heavy Duty Kit - 30"	61
HO Series	Hang Up	9
HP06K	HydroPower Starter 14' Kit	50
HP06T	HydroPower 1-Stage	10
HP12C	HydroPower 2-Stage	10
HP12T	HydroPower 2-Stage	10
HP24C	HydroPower 4-Stage	10
HP24T	HydroPower 4-Stage	10
<b>HPAN6</b>	<b>HydroPower Entry 20' Kit</b>	<b>9</b>
HPB06	Replacement Resin Bags - 1	10
HPB24	Replacement Resin Bags - 4	10
<b>HPNL3</b>	<b>HydroPower Professional 55' Kit</b>	<b>9</b>
<b>HPNL6</b>	<b>HydroPower Professional 33' Kit</b>	<b>9</b>
HT000	Leather Holster	25
HT150	ErgoTec® Ninja Scraper Holster	21
HT35G	HiFlo™ nLite® Hybrid Extension Pole	11
HT67G	HiFlo™ nLite® Hybrid Master Pole	11
HTK14	HiFlo™ nLite® Hybrid Starter Kit - 22'	12
HU Series	Hold Up	50
HW30A	SmartFit™ WaterWand™ Heavy Duty - Red	61
HW750	WaterWand™ Heavy-Duty - Red	58

## L

LA000	ErgoTec® Swiveloc 30°	20
LH12C	4" Light Duty Scraper	56
LS000	ErgoTec® Swiveloc 0°	20
LWDU0	StarDuster® LambSwool	35
LWDUR	StarDuster® Pro Duster	35

Part No.	Product Name	Page No.
----------	--------------	----------

## M

MA450	SmartColor™ Spill Mop 1L	53
MB40 Series	MicroWipe™ 2000 Medium-Duty	47
MC40 Series	MicroWipe™ 500 Light-Duty	47
MC Series	Monsoon Plus StripWasher® Complete	16
MD40 Series	SmartColor™ Micro Mop 7.0	53
MDSB0	6" Replacement Blades	56
MDSCO	6" Medium-Duty Scraper	56
ME40 Series	MicroWipe™ 200 UltraLite	47
MF40 Series	MicroWipe™ 4000 Heavy-Duty	47
MF Series	MicroWipe™	24
MK1TR	Restroom Master Cleaning Kit	46
MM40 Series	SmartColor™ Micro Mop 15.0	53
MMIRG	Micro Mitt HeavyDuty	35
MMSLG	Pro Micro Sleeve	35
MN Series	Ninja MicroWipe™	24
MS Series	Monsoon Plus StripWasher® Sleeve	17
MS14G	Mop Handle 140 KD	55
MW Series	WaterWand™ Standard	58
MW18A	SmartFit™ WaterWand™ Standard - 18"	61
MW18A	SmartFit™ WaterWand™ Standard - 22"	61

## N

NA Series	ErgoTec® Ninja Washer Complete	16
NB300	NiftyNabber® Bagger	63
NC Series	Micro StripWasher® Complete	16
NCANO	ErgoTec® Locking Cone - Green	37
NCANR	ErgoTec® Locking Cone - Red	55
NE Series	"S" Channel	20, 48
NI Series	ErgoTec® Ninja T-Bar	17
NJ Series	ErgoTec® Ninja Sleeve	17
NL Series	HiFlo™ nLite® Brush	13
NLK15	HiFlo™ nLite® Extension 5' Kit	12
NLKU3	HiFlo™ nLite® HiMod 55' Kit	12
NLKU6	HiFlo™ nLite® HiMod 33' Kit	12
NN Series	NiftyNabber® Pro	63
NS Series	Micro StripWasher® Sleeve	17
NS45R	SmartColor™ Washer 15.0 - Sleeve	48
NT Series	NiftyNabber® Trigger Grip	63

## O

OPS20	Scrub Pad	31
OS Series	UniTec™	38

## P

PB Series	Sanitary Brush	58
PB45R	Sanitary Brush - Red	55
PBR00	Universal Adapter	37
PCLIP	Plastic Clips and Case	20
PF7G	StarDuster® ProFlat 75	35

Part No.	Product Name	Page No.
----------	--------------	----------

PB55G	SmartFit™ Sanitary Brush - 22"	61
PHD20	Handheld Aluminum Pad Holder	31
PHH20	Aluminum Pad Holder	31
PHL20	Microfiber Cleaning Pad	31
PHW20	Microfiber Washing Pad	31
PINPO	Replacement Pin Plugs	63
PIPE0	StarDuster® Pipe Brush	36
PL Series	The Pill Glass Cleaner	24
PM Series	Sanitary Standard	58
PM45G	SmartFit™ Sanitary Standard - 18"	61
PM55G	SmartFit™ Sanitary Standard - 22"	61
PM55K	SmartFit™ Sanitary Standard Kit - 22"	61
PM05W	StarDuster® ProFlex/ProFlat Sleeves	35
PPLUG	ErgoTec® Ninja End Clips	18
PPPP0	People's Paper Picker Pin	63
PR Series	Pro Stainless Steel Squeegee Complete	19
PS50W	StarDuster® ProFlex/ProFlat Sleeves	35
PWK00	Pro Window Cleaning Kit	24
PXD7G	StarDuster® ProFlex 75	35

## Q

QB060	Bucket Sieve	25, 50
QB080	Pro Bucket Lid	25, 50
QB120	4.5 Gallon Bucket w/ Sieve	25, 50
QB220	Pro Bucket	25, 50
QS010	Wonder Waxer Replacement Sleeve	54
QS140	Wonder Waxer Complete	54

## R

RB Series	Replacement Blades - Carbon Steel	22, 56
RC Series	The Pad StripWasher® Complete	16
RG H Series	Hard Replacement Rubber	20
RG Series	Ergo Soft Rubber Gross Packs	20
RP Series	Promo Pack ErgoTec® Soft Rubber	20
RRBSC	RestroomRx Cleaning Double Supply Cart	45
RRCRT	RestroomRx Cleaning Cart	45
RRPRO	Pro Restroom Cleaning Kit - Flat Mop	46
RRSPC	RestroomRx Cleaning Specialist System Complete - 16 Qt.	45
RRSPL	RestroomRx Cleaning Specialist System Complete - 32 Qt.	45
RRSPS	RestroomRx Cleaning Specialist System - Starter	45
RS Series	The Pad StripWasher® Sleeve	17
RT Series	ErgoTec® Soft Rubber - 12 Packs	20
RUB50	RubOut	24

## S

SB20G	SmartColor™ Swivel Brush	55
SCFPG	SmartColor™ Floor Pack - 32 Qt.	52
SH00C	ErgoTec® Scraper	23
SH25C	The Brute Scraper	22
SM40 Series	SmartColor™ EZ Flat Mop Holder	53
SMCMR	Restroom Complete Mop Pack	46

Part No.	Product Name	Page No.
----------	--------------	----------

SMFPR	Restroom Floor Pack	46
SMSBG	SmartColor™ Side Bucket	52
SOABG	Sprayer On A Belt	31
SP010	The Sponge	37
SP060	Soot Master Sponge	37
SRB Series	Safety Scraper Replacement Blades	22
SR040	ErgoTec® Safety Scraper	21
SR500	Safety Scraper - Stainless Steel	21
SRBDB	Safety Scraper Replacement Blades	23
<b>STBAG</b>	<b>Stingray Carrying Bag</b>	<b>29</b>
<b>SREPL</b>	<b>Stingray Extension Pole - Long</b>	<b>29</b>
<b>SREPS</b>	<b>Stingray Extension Pole - Short</b>	<b>29</b>
<b>SRKT4</b>	<b>Stingray Indoor Cleaning Kit - Handheld</b>	<b>29</b>
<b>SRKT5</b>	<b>Stingray Indoor Cleaning Kit - 3'</b>	<b>29</b>
<b>SRKT6</b>	<b>Stingray Indoor Cleaning Kit - 10'</b>	<b>29</b>
<b>SRKT7</b>	<b>Stingray Indoor Cleaning Kit - 5'</b>	<b>29</b>
<b>SRKT7</b>	<b>Stingray Indoor Cleaning Kit Deluxe - 10'</b>	<b>29</b>
<b>SRL02</b>	<b>Stingray Professional Glass Cleaner</b>	<b>29</b>
<b>SRPD1</b>	<b>Stingray Glass Cleaning Pad</b>	<b>29</b>
<b>SRPD2</b>	<b>Stingray Deep Cleaning Pad</b>	<b>29</b>
ST30 Series	SmartColor™ RoughMop ST30 Series	54
ST45 Series	SmartColor™ RoughMop ST45 Series	54
STMIN	Mini Scraper	21
SV Series	Swivel Strip T-Bar	17
SV40G	Damp Mop Pad Holder	54

## T

T3180	Plus 3	39
T4180	Plus 4	39
T5180	Plus 5	39
TD500	TelePlus™ 6'/1.85m System	39
TM100	Trim 10 Scraper	21
TMOOV	HiFlo™ Control	14
TR Series	Trim/Glass Scraper Replacement Blades	23
TR500	Tran-Set Cleaning Kit	24
TWA00	Threader Wood Cone Adapter	37
TX100	ProTrim 10	22

## U

UB000	The Belt	25
UC35G	HiFlo™ nLite® HiModulus Extension Pole	11
UC67G	HiFlo™ nLite® HiModulus Master Pole	11
US300	UniTec™ Lite Squeegee	19

## V

VP Series	VisaVersa®	19
-----------	------------	----

## W

WALB0	StarDuster® Wall Brush	36
WC Series	The Original StripWasher® Strip Pac	16
WH180	Easy Adapter Hose	52
WNK04	SpeedClean™ Starter Kit	30
WS Series	The Original StripWasher® Sleeve	17



Quality Tools for Smart Cleaning™

# 100% CUSTOMER SATISFACTION GUARANTEE

At Unger, we aim to stand apart from the rest thanks to our special "Yes We Can!" service spirit. We love what we do and as proof of that, we promise to deliver a 100% Customer Satisfaction Guarantee on every product and service we offer.

**Terms and Conditions:** Unger works directly with qualified distributors and established industry buying groups. To qualify as an approved distributor, your company shall already be established with other manufacturers for resale, have warehouse/inventory capacity, and be exempt from paying sales tax. Distributor status subject to Region Manager approval and periodic review. Overdue accounts are subject to a finance fee of 1½% per month on open balances. All prices are F.O.B. Bridgeport, CT and are subject to change without notice. Invoice terms are net 30 days from shipping date. Visa/MasterCard and Discover Card are accepted and are debited the day of order. Payment in US funds only.

**US Shipments:** UPS Orders over \$900 or LTL Truck orders\* over \$1,200 are shipped freight free within the 48 contiguous states. Non qualifying orders will incur freight charges prepaid to invoice.

**Broken Case Policy:** All products are available in less than one case quantity with the exception of prepackaged items such as: MicroWipes, Replacement Rubber/Blades, Duster Sleeves, and Poles. A 20% broken case surcharge per item will automatically apply.

**Quick Delivery:** We ship in-stock merchandise within 2 business days, with standard delivery, you can expect your order in just 1-6 days. Special shipping requests subject to additional freight charges such as Next Day, 2nd & 3rd Day fees. Orders with line item(s) exceeding 50 cases can take up to 6 weeks delivery.

**Order Qualifications:** Minimum order of \$350

**Drop Ship:** Provided the above minimums are achieved, Unger will drop ship orders directly to end users. The distributor will pay Unger a \$25 fee per drop ship location plus shipping costs.

**Claims:** Return Goods Authorization (RGA) is required for returning merchandise. The goods must be in new, saleable condition, in original Unger packaging and are subject to a 20% restocking charge. Claims for shortages or damages must be made within 5 days of receipt of goods.

**International Shipments:** All international orders are shipped duties and taxes UNPAID and the customer is responsible for such fees upon delivery of items. Canadian Shipments: Freight Free-Order minimum is \$1,000 for standard UPS shipments, LTL shipments \$1,500.

**Non-Canadian Shipments:** Ships to US Freight Forwarder and standard US Shipment minimums apply. US Dollars only.

**Notes:** Possession of this price list does not constitute an offer to sell. Unger Enterprises is not responsible for delays beyond our control.

\*Selected Poles ship by truck only – EZ500, EZ600, ED750, ED900. Minimum of 10 poles required. Use any combination of sizes to reach minimum.

Unger Enterprises, LLC  
425 Asylum Street  
Bridgeport, CT 06610  
Tel.: (1) 800.431.2324  
Fax: (1) 800.367.1988  
unger@ungerglobal.com

Unger Germany GmbH  
Piepersberg 44  
D-42653 Solingen  
Tel.: (49) 212 2207 0  
Fax: (49) 212 2207 222  
ungereurope@ungerglobal.com

Unger UK Ltd.  
9 Planetary Ind. Est.  
Willenhall, WV13 3XA  
Tel.: (44) 01902 306633  
Fax: (44) 01902 306644  
ungeruk@ungerglobal.com

Unger France SARL  
114 bis rue Michel-Ange  
75016 Paris  
Tel.: (33) 1 40 71 28 70  
Fax: (33) 1 40 71 28 45  
ungerfrance@ungerglobal.com